



# SKYSTONE<sup>SM</sup>

PRESENTED BY **Qualcomm**

---

*FIRST<sup>®</sup> RISE<sup>SM</sup> powered by Star Wars: Force for Change*

*2019-2020 FIRST<sup>®</sup> Tech Challenge*

## Game Manual Part 2



**FIRST** **RISE**<sup>SM</sup>

POWERED BY  
**STAR WARS**<sup>SM</sup>  
FORCE FOR CHANGE

## Sponsor Thank You

Thank you to our generous sponsors for your continued support of the *FIRST*® Tech Challenge!

***FIRST*® Tech Challenge  
Season Presenting Sponsor**

The Qualcomm logo is displayed in a bold, blue, sans-serif font.

***FIRST*® Tech Challenge  
Official Program Sponsor**

The Collins Aerospace logo features a stylized sunburst or gear-like icon to the left of the company name.

**Collins Aerospace**

***FIRST*® Tech Challenge  
Official 3D Augmented Reality/  
Virtual Reality Sponsor**

The PTC logo consists of a stylized green and grey geometric icon followed by the lowercase letters "ptc" in a grey, sans-serif font.

## Revision History

Revision History			
Section	Revision	Date	Description
N/A	1	8/20/2019	Affiliate Partner Limited Release
Section 4	1.1	9/7/2019	<ul style="list-style-type: none"> <li>Added section 4.2.1 – Game Narrative</li> <li>Section 4.6.2 – Moved orange box from &lt;G25&gt; to &lt;G23&gt;</li> <li>Section 4.6.3, Rule &lt;GS1&gt; – Added new &lt;GS1&gt;a, f &amp; g</li> <li>Section 4.6.3 – Added rule &lt;GS12&gt;</li> <li>Appendix E – Updated images to update game terminology</li> </ul>

## Contents

Contents .....	3
1.0 Introduction.....	5
What is <i>FIRST</i> ® Tech Challenge? .....	5
<i>FIRST</i> Core Values .....	5
2.0 <i>Gracious Professionalism</i> ® .....	5
3.0 How to Use This Document .....	5
4.0 The Game .....	6
4.1 Introduction .....	6
4.2 Game Description .....	6
4.2.1 Game Narrative: .....	6
4.3 Playing Field Illustration .....	7
4.4 Game Definitions .....	8
4.5 Gameplay .....	13
4.5.1 Pre-Match.....	13
4.5.2 Autonomous Period .....	13
4.5.3 Driver-Controlled Period .....	14
4.5.4 <i>End Game</i> .....	15
4.5.5 Post Match .....	15
4.5.6 Penalty Scoring .....	15
4.5.7 Flowchart of Match Play .....	16
4.6 Rules of Gameplay.....	16
4.6.1 Safety Rules .....	16
4.6.2 General Game Rules .....	17
4.6.3 Game-Specific Rules .....	22
4.7 Scoring Summary.....	25
4.8 Rule Summary .....	25
Appendix A – Resources .....	29

Game Forum Q&A .....	29
<i>FIRST</i> Tech Challenge Game Manuals.....	29
<i>FIRST</i> Headquarters Pre-Event Support.....	29
<i>FIRST</i> Websites.....	29
<i>FIRST</i> Tech Challenge Social Media .....	29
Feedback.....	29
Appendix B – Field Details.....	30
Appendix C – Scoring Elements .....	34
Appendix D – Quarry Randomization.....	36
Appendix E – Scoring Examples.....	37

## 1.0 Introduction

---

### **What is FIRST® Tech Challenge?**

FIRST® Tech Challenge is a student-centered program that focuses on giving students a unique and stimulating experience. Each year, teams engage in a new game where they design, build, test, and program autonomous and driver operated robots that must perform a series of tasks. To learn more about FIRST® Tech Challenge and other FIRST® Programs, visit [www.firstinspires.org](http://www.firstinspires.org).

### **FIRST Core Values**

We express the FIRST® philosophies of *Gracious Professionalism®* and *Coopertition®* through our Core Values:

- **Discovery:** *We explore new skills and ideas.*
- **Innovation:** *We use creativity and persistence to solve problems.*
- **Impact:** *We apply what we learn to improve our world.*
- **Inclusion:** *We respect each other and embrace our differences.*
- **Teamwork:** *We are stronger when we work together.*
- **Fun:** *We enjoy and celebrate what we do!*

## 2.0 Gracious Professionalism®

---

FIRST® uses this term to describe our programs' intent.

*Gracious Professionalism®* is a way of doing things that encourages high-quality work, emphasizes the value of others, and respects individuals and the community.

Watch Dr. Woodie Flowers explain *Gracious Professionalism* in this [short video](#).

## 3.0 How to Use This Document

---

The Game Manual Part 2 is a resource for all FIRST® Tech Challenge *Teams* for information specific to the 2019-2020 season's game.

The intent of this manual is that the text means exactly, and only, what it says. Please avoid interpreting the text based on assumptions about intent, implementation of past rules, or how a situation might be in "real life". There are no hidden requirements or restrictions. If you have read everything, you know everything.

Key words that have a specific meaning within this document are defined in the Game Definitions section and are indicated with the first letter capitalized, and the entire word in *Italics*.

## 4.0 The Game

---

### 4.1 Introduction

This document describes SKYSTONE<sup>SM</sup> presented by Qualcomm®, the FIRST® Tech Challenge game for the 2019-2020 season. *Teams* must comply with all rules and requirements stated in this document and in the Game Manual Part 1. Clarifications to the game rules are issued on the Question & Answer section of the forum at [ftcforum.usfirst.org](http://ftcforum.usfirst.org). Forum rulings take precedence over information in the game manuals.

### 4.2 Game Description

*Matches* are played on a *Playing Field* initially set up as illustrated in Figure 1.3-1 below. Two *Alliances* – one “Red” and one “Blue”, composed of two *Teams* each – compete in each *Match*. The object of the game is to attain a higher score than the opposing *Alliance* by locating and delivering *Stones* and *Skystones* from the *Loading Zone* to the *Building Zone*, building the highest *Skyscraper*, and placing the *Capstone* on the *Skyscraper*. The game is played in two distinct periods: *Autonomous* and *Driver-Controlled*.

The *Match* starts with a 30-second *Autonomous Period* in which *Robots* operate using only pre-programmed instructions and sensor inputs. During the *Autonomous Period*, *Alliances* earn points by: Repositioning their *Foundation* in their *Building Site*; *Delivering Stones* from the *Loading Zone* to the *Building Zone*; *Placing Stones* on their *Foundation*; and *Navigating* their *Robots* under their segment of the *Skybridge*.

The two-minute *Driver-Controlled Period* follows the *Autonomous Period*. During the *Driver-Controlled Period*, *Alliances* earn points by *Delivering* and *Placing Stones* from the *Loading Zone* to the *Building Stone*. *Robots* will also build *Skyscrapers* to go as high as possible without toppling over.

The final 30 seconds of the *Driver Controlled Period* is called the *End Game*. In addition to the previously listed *Driver-Controlled Period Scoring* activities, *Alliances* earn points by *Capping* their *Skyscrapers* with a *Team-supplied Capstone*, moving their *Foundations* out of the *Building Site*, and *Parking* their *Robot* in their *Building Site*.

#### 4.2.1 Game Narrative:

Like the towering structures on the planet of Coruscant in Star Wars, *FIRST City* is growing and must be resilient and strategic to sustain life and a rising population.

In SKYSTONE<sup>SM</sup>, your mission is to create a structure that pushes into the skies to represent your alliance.

On your journey, you will work with droid allies to overcome obstacles that stand in your path to building a superstructure of the future and top it off with a crown of achievement—a final capstone to symbolize our reach into the sky, and dreams of a hopeful future.





#### 4.4 Game Definitions

The following definitions and terms are used in SKYSTONE<sup>SM</sup> presented by Qualcomm®:

**Alliance** – Each FIRST Tech Challenge *Match* consists of two, two-*Team Alliances*. These two *Teams* compete against an opposing *Alliance* (also made up of two *Teams*) to complete the game challenge and to earn the highest score. At tournaments with more than 20 *Teams*, the semi-final and final round *Alliances* consists of three *Teams* each. However, only two of those *Teams* compete during any one *Match*.

**Alliance Station** – The designated “Red” or “Blue” *Alliance Area* adjacent to the *Playing Field* where the *Drivers* and *Coach* stand during a *Match*.

**Area** – The space defined by the vertical projection of the outside edge of a region’s boundary (for example, gaffers tape, goal, *Playing Field Wall*). The boundary element (tape, wall, markings, etc.) is part of the *Area* for the purposes of determining *Inside* and *Outside*.

**Autonomous Period** – A thirty-second period in which the *Robots* operate and react only to sensor inputs and to commands pre-programmed by the *Team* onto the onboard *Robot* control system. Human control of the *Robot* is not permitted during this time.

**Block / Blocking** – Preventing an opposing *Alliance Robot* from accessing an *Area* or *Game Element* for an extended period by obstructing ALL paths of travel to the object or *Area*. Active defense played by a *Robot* shadowing an opposing *Alliance Robot* that eliminates all paths of travel between the opposing *Alliance Robot* and an *Area* or *Alliance-specific Game Element* or all remaining *Alliance-neutral Game Elements* is considered *Blocking*, even though at any frozen point in time there is an open path. See also *Trap / Trapping* (which may be considered the same except it is from a *Game Element* or *Area* of the *Playing Field*).

**Building Site** – An *Area* on the *Playing Field* marked off in red or blue tape. There is one (1) *Red Alliance Building Site* and one (1) *Blue Alliance Building Site*. The taped off area is right triangular shaped with 22.75 inch (57.8 cm) sides.

**Building Zone** – The *Area* between the *Skybridge* and the back (furthest from the audience) *Playing Field Wall*. For the purpose of *Deliver* and *Return*, the *Alliance* colored tapes and the black *Floor Plate* define the separation between the *Loading* and *Building Zone* but are not part of either *Zone*.

**Capstone** – A *Team* supplied *Scoring Element* that has passed inspection.

**Capping** – A *Capstone* is placed onto a *Foundation* and the *Capstone* is fully supported by only the *Stones*, *Foundation* or another legally scored *Capstone* and not in contact with a corresponding *Alliance Robot*.

**Coach** – A student *Team* member or adult mentor designated as the *Drive Team* advisor during the *Match* and identified by wearing a “Coach” badge or identifying marker.

**Competition Area** – The *Area* where all the *Playing Fields*, *Alliance Stations*, scoring tables, on-deck queuing tables, event officials, and other tournament items relating to *Match* play are located. The *Team Pit Area* and practice *Playing Fields* are not part of the *Competition Area*.

**Control / Controlling** – An object is *Controlled* by a *Robot* if the object is following the movement of the *Robot*. Objects that are *Controlled* by a *Robot* are part of the *Robot*. See *Possess / Possessing* to learn about a related term. Examples include, but are not limited to:

- Carrying – holding one or more *Game Elements* *Inside* or *Outside* of a *Robot*.
- Herding – pushing or impelling one or more *Game Elements* to a desired location or direction that gains a strategic advantage beyond moving the *Robot* around the *Playing Field*.



- **Holding** – *Trapping* one or more *Scoring Elements* against a *Game Element*, *Playing Field Wall*, or *Robot* to shield or guard them.
- **Launching** – see definition below.

Examples of interaction with *Game Elements* that are not *Controlled* include, but are not limited to:

- **Plowing** – *Inadvertent* contact with *Game Elements* while in the path of the *Robot* moving about the *Playing Field*.
- **Deflecting** – *Inadvertent* contact with a *Launched Game Element* as it bounces off a *Robot*.

**Deliver** – A *Robot* moving an individual *Stone* from the *Loading Zone* to the *Building Zone*. The *Stone* must be *Controlled* by a *Robot*, and the *Robot* must travel from *Completely In the Loading Zone* to *Completely In the Building Zone* for the *Stone* to be considered *Delivered*.

**Depot** – An *Area* on the *Playing Field* marked off in red or blue tape. There is one (1) *Red Alliance Depot* and one (1) *Blue Alliance Depot*. The taped off *Area* is approximately 24 inches (61 cm) x 24 inches (61 cm).

**Disable / Disabled** – A *Robot* that is no longer active for the remainder of the *Match* due to a *Robot* failure or by the request of a referee. *Drive Teams* may not *Disable* a *Robot* without the permission of a Field Technical Advisor or Referee. If a referee *Disables* a *Robot* during a *Match*, they will ask the *Team* to drive their *Robot* to a neutral position on the *Playing Field*, issue a stop command with the *Driver Station*, and place their *Driver Station* in a hands-off location on a tournament-provided structure or the *Alliance Station* floor.

**Disqualified / Disqualification / Disqualify** – A *Team* that is ineligible to compete in a *Match*. A *Team* that is *Disqualified* from a *Match* will not receive credit for the *Match* (that is, no Ranking or TieBreaker points).

**Drive Team** – Up to four representatives two (2) *Drivers*, one (1) *Coach*, and one (1) *Human Player* from the same *Team*. Only one (1) *Human Player* represents an entire *Alliance* in a *Match*.

**Driver** – A pre-college student *Team* member responsible for operating and controlling the *Robot* and identified by wearing a tournament supplied “*Driver*” badge or identifying marker.

**Driver-Controlled Period** – The two-minute time period in which the *Drivers* operate the *Robots*.

**Driver Station** – Hardware and FIRST supplied software used by a *Drive Team* to control their *Robot* during a *Match*. A detailed description of *Driver Station* is listed in Game Manual Part 1.

**End Game** – The last thirty seconds of the two-minute *Driver-Controlled Period*.

**End of the Period/Match** - The moment when the *Match* timer reaches 0:00. Also known as *Time Zero* or *T=0.00*.

**Foundation** – A *Scoring Element* for SKYSTONE<sup>SM</sup>. There are two (2) *Alliance* specific *Foundations*, one (1) Red and one (1) Blue. The *Foundations* are approximately 18.5 inches (469.9 mm) wide x 34.5 inches (876.3 mm) long x 2 inches (50.8 mm) tall.

**Game Element** – Any item *Robots* or *Human Players* interact with to play the game. *Game Elements* for this year’s game include: *Stones*, *Foundations*, *Skybridges*, and *Capstones*.

**Human Player** – A student *Team* member that supplies *Stones* and *Capstones* to the *Depot* and is identified by wearing a tournament supplied “*Human Player*” badge or identifying marker. Only one *Human Player* represents the entire *Alliance*. For *Qualification Matches*, an *Alliance* must decide which *Team* will

name the *Human Player*. If the *Alliance* cannot decide quickly, the *Team* listed in the match list as "Red 1" or "Blue 1" for the *Alliance* has the responsibility for naming the *Human Player*. The *Human Player* must be from the *Teams* that are in the *Match*. For *Elimination Matches*, the captain of the *Alliance* has that responsibility.

**Human Player Station** – The *Area* where the *Human Player* stands during a *Match*.

**In (Inside) / Completely In (Completely Inside)** – An object that has crossed into the upwards vertical (i.e., at a right angle to the *Playing Field Floor*) extension of a defined *Area*'s boundary is *Inside* the *Area*. An object that is entirely within the upwards vertical extension of a defined *Area*'s boundary is *Completely Inside* the *Area*. The boundary element (tape, wall, markings, etc.) is part of the *Area* for the purposes of determining *Inside* and *Outside*, unless otherwise specified. However, the Red and Blue tape under the *Alliance Skybridges* and the Floor Plate under the neutral *Skybridge* that separate the *Loading Zone* from the *Building Zone* are not part of either zone.

**Inadvertent** – An outcome that is not a planned strategy and not the predictable result of persistent or repeated actions.

**Inconsequential** – An outcome that does not influence *Scoring* or gameplay.

**Interference** - Interaction between opposing *Alliance Robots* that amplifies the difficulty of a *Scoring* activity. Actions that constitute *Interference* should not be considered illegal except as specified by a *Game Rule*.

**Interlocked** – The condition where a stud of a *Stone* or *Foundation* fits in the recess in a *Stone*.

**Launching** – Propelling *Game Elements* with enough force such that they can move independent of contact with the *Robot* or *Human Player*.

**Loading Zone** – The *Area* between the *Skybridge* and the front (closest to the audience) *Playing Field Wall*.

**Match** – A head-to-head competition between two *Alliances*. A *Match* consists of a thirty-second *Autonomous Period* followed by a two-minute *Driver-Controlled Period* for a total time of two minutes and thirty seconds.

**Navigation Target** - Eight (8) unique images mounted on the *Playing Field Walls* (two (2) images per wall) that *Robots* can use to navigate around the *Playing Field*. Images are printed on standard letter size paper, 8 1/2 inches x 11 inches (216 mm x 279 mm) or A4 (210 mm x 297 mm) paper.

The *Skybridge* has four (4) unique *Navigation Targets*, two in the *Loading Zone* and two (2) in the *Building Zone*. Each image measures approximately 13 inches (33 cm) x 1.875 inches (4.7 cm).

**Off** – Not physically in contact with or *Supported* by an object, surface, etc. Objects that are *Off* are also considered *Completely Off*.

**On / Completely On** – An object that is physically in contact with and at least partially *Supported* by an object, surface, etc. is considered *On*. An object that is entirely *Supported* by another object, surface, etc. is *Completely On*.

**Out / Outside** – An object that has not crossed into any part of a defined *Area* is *Outside* the *Area*.

**Park / Parked** – The condition where a *Robot* is motionless.

**Penalty** – The consequence imposed for a rule or procedure violation that is identified by a referee. When a *Penalty* occurs, points will be awarded to the *Alliance* that did not incur the *Penalty*. *Penalties* are further defined into *Minor Penalties* (five (5) points) and *Major Penalties* (twenty (20) points). *Penalties* may also

escalate to issuing of a *Yellow Card* or *Red Card* as a result of a continued occurrence of a rule violation and upon discretion of the Referee.

**Yellow Cards and Red Cards** – In addition to rule violations explicitly listed in section 4.6, *Yellow Cards* and *Red Cards* are used in the *FIRST* Tech Challenge to manage *Team* and *Robot* behavior that does not align with the mission of *FIRST*. *Yellow* and *Red Cards* are not limited to just the *Competition Area*. *Teams* that display egregious behavior in the pit area, judging rooms, stands, or any other location of the tournament can be issued a yellow or red card for egregious behavior.

Egregious behaviors or behaviors that are repeated (3 or more) times by a *Robot* or *Team* member at the tournament can result in a *Yellow* and/or *Red Card*. *Yellow Cards* are additive, meaning that a second *Yellow Card* is automatically converted to a *Red Card*. A *Team* is issued a *Red Card* for any subsequent incident in which they receive an additional *Yellow Card*, for example, earning a second *Yellow Card* during a single *Match*.

*Yellow* and *Red Cards* may also be issued on or off the competition field. For details please make sure to read the Tournament Rules outlined in section 4.2 of the [Game Manual Part 1](#).

**Pin / Pinning** – Preventing the movement in all directions of an opposing *Alliance Robot* while it is in contact with the *Playing Field Wall*, one or more *Game Elements*, or another *Robot*.

**Playing Field** – The part of the *Competition Area* that includes the 12 ft. x 12 ft. (3.66 m x 3.66 m) field and all the *Game Elements* described in the official field documents. From the audience viewpoint, the *Red Alliance Station* is on the right side of the *Playing Field*.

**Playing Field Damage** – A physical change to a *Game Element* or *Playing Field* that affects gameplay or an action that causes harm to the playability of a *Game Element* or *Playing Field*.

**Playing Field Floor** – The top surface of the *Tiles* that make up the base of the *Playing Field*.

**Playing Field Perimeter** – The outside face of the *Playing Field Wall*.

**Playing Field Wall** – An approximate 12 inches (30.5 cm) tall, 12 ft. (3.66 m) long by 12 ft. (3.66 m) wide wall surrounding the *Playing Field Floor*. The height of the *Wall* will vary depending on which *Playing Field Wall* is being used at the event. *Robots* should be built to interact with all legal *Playing Field Walls*.

**Possess / Possessing** – An object is in *Possession* by a *Robot* if, as the *Robot* moves or changes orientation (for example, moves forward, turns, backs up, spins in place), the object remains in approximately the same position relative to the *Robot*. Objects in *Possession* by a *Robot* are considered to be *Controlled*, and they are part of the *Robot*. See also *Control/Controlling*.

**Pre-Load** - A *Game Element* that a *Drive Team* positions during pre-*Match* setup so that it is *Possessed* by a *Robot* at the start of the *Autonomous Period*.

**Quarry** – A structure made of four (4) *Stones* and two (2) *Skystones*. All six (6) *Stones/Skystones* are positioned end to end along the floor *Tile* tab edge, see the Field Setup Guide for the exact location. Prior to the start of the *Match* the six (6) *Stones/Skystones* are positioned in one of three (3) randomly selected configurations. See Appendix D.

**Return** – Moving a *Stone* from *Completely In* the *Building Zone* to *Completely In* the *Loading Zone*. *Stones Returned* to the *Loading Zone* will deduct the points from the *Alliance's Score*, regardless of the location of the *Robot*. Points will not be deducted for *Stones* accidentally *Returned* as a result of a falling *Skyscraper*.

**Robot** – Any mechanism that has passed *Robot* inspection and a *Drive Team* places on the *Playing Field* prior to the start of a *Match*. A detailed definition of *Robot* is in the *Robot* rules section in the Game Manual Part 1.

**Scoring / Score** – *Robots* earn points for their *Alliance* by interacting with *Scoring Elements* and *Parking* in specific *Areas* of the *Playing Field*. *Scoring Elements* are *Scored* when they are placed in the appropriate location and are no longer in contact with a *Robot* from the corresponding *Alliance*. The *Scoring* achievements and their point values are described in section 4.5.

**Scoring Elements** – Objects that *Robots* manipulate to earn points for their *Alliance*. The *Scoring Elements* for SKYSTONE<sup>SM</sup> are *Stones*, *Foundations*, and *Capstones*.

**Skybridge** – A *Field Element* that divides the *Playing Field*. The *Skybridge* consists of three sections, a *Red Alliance* section that has 14 inch (355.6 mm) clearance between the pipe and the *Playing Field Floor*, an *Alliance Neutral* section with a 20 inch (508 mm) clearance, and a *Blue Alliance* section that has 14 inch (355.6 mm) clearance.

**Skyscraper** – *Stone(s)* that satisfy the following criteria:

- a) The *Stones* on the lowest *Level* in a *Skyscraper* must be *Interlocked* with the *Foundation*. All the remaining *Stones* of the *Skyscraper* must be *Interlocked* with another *Stone* in the *Skyscraper*.
- b) The *Alliance's Robot* must not be in contact with any of the *Stones* in the entire *Skyscraper*.

See Appendix E for examples of *Skyscrapers*.

**Skyscraper Level** – A layer of *Stones* that is used to form a *Skyscraper*. *Skyscraper Levels* must be supported from beneath by either the *Foundation*, or by being *Interlocked* with a *Stone* from the level beneath them (See Appendix E for examples).

**Skystone** – A *Scoring Element* for SKYSTONE<sup>SM</sup>. The *Skystone* is the same size and shape as a *Stone*, and it has an image on one of the long sides and wrapped onto the top. There are four (4) *Alliance neutral Skystones*. Each image measures approximately 7 inches (177.8 mm) x 4.75 inches (120.7 mm).

**Stone** – A *Scoring Element* for SKYSTONE<sup>SM</sup>. The approximate dimensions are 8 inch (203.2 mm) x 4 inch (101.6 mm) x 5 inch (127 mm) tall. There are fifty-six (56) *Alliance neutral Stones*.

**Stone Supply** – The supply of *Stones* that the *Human Player* uses during a *Match*.

**Support / Supported / Completely Supported** – An object (i.e. *Robot*, *Scoring Element*, *Game Element*, etc.) is supported by another object if the second object is bearing at least some of the weight of the first object. If the second object is bearing all of the weight of the first object, it is completely supported by the second object.

**Team** – Mentors, supporters, and pre-college-aged students affiliated with an entity registered with FIRST and for the competition.

**Tile** – The approximately 24 inch x 24 inch (609.6 mm x 609.6 mm) foam rubber mat, 36 of which make up the *Playing Field Floor*.

**Trap / Trapping** – Preventing an opposing *Alliance Robot* from escaping a constrained *Area* of the *Playing Field* or from a *Game Element* for an extended period of time by obstructing all paths of travel from the object or *Area*. See also *Block / Blocking* (which may be considered the same except it is to a *Game Element* or *Area* of the *Playing Field*).



## 4.5 Gameplay

Prior to the start of the *Match*, *Drive Teams* perform some basic *Robot* setup steps that are described in section 4.5.1. *Matches* are made up of several periods totaling two minutes and thirty seconds. There is a thirty-second *Autonomous Period*, followed by a two-minute *Driver-Controlled Period*. The last thirty seconds of the *Driver-Controlled Period* is called the *End Game*. When the *Match* is over and referees signal, *Drive Teams* collect their *Robots* and *Capstones*, return *Game Elements*, and exit the *Competition Area*.

### 4.5.1 Pre-Match

Field personnel will place twenty-four (24) *Stones* into each of two (2) *Stone Supplies*.

*Teams* have the option to pre-load only one (1) *Capstone* into their *Robot* prior to the start of the *Match*. *Teams* that elect not to pre-load their *Capstone* may introduce it into the *Depot* via their *Alliance's Human Player* at any time during the *Driver-Controlled Period*. *Capstones* that are not pre-loaded on the *Robot* must be placed adjacent to the *Stone Supply*.

Prior to setting up on the *Field*, the *Alliance Partner Teams* will decide which *Team* of their *Alliance* supplies the *Human Player*. Only one *Human Player* for an *Alliance* may come to the *Field* from the *Queuing Area*. *Drive Teams* with the concurrence of their *Alliance Partner*, select their *Robots'* starting locations with the following constraints:

- 1) *Drive Teams* must place their *Robots*, in any orientation, touching the *Playing Field Wall* adjacent to their *Alliance's Driver Station*.
- 2) A *Robot* may not contact another *Robot*.
- 3) A *Robot* may not start *In* the *Depot*

When the *Robots* and *Drive Teams* are in position, the *Human Player* must also be *In* their *Human Player Station* and stay there for the remainder of the *Match*.

Once the Referees give the set up complete signal:

- 1) *Drive Teams* may no longer touch their *Robots* until the conclusion of the *Match*, and
- 2) *Drive Teams* may not touch their *Driver Stations* or *Controllers* until the *Autonomous Period* has ended, except to initialize and/or start their *Autonomous* program using the *Driver Station* Android device screen. *Robots* that require *Autonomous* program initialization to satisfy the *Robot* starting volume constraint must be initialized before Referees give the set up complete signal.

Prior to the start of the *Match*, *Referees* will place six (6) *Stones* into each of two (2) *Quarries* with the *Skystones* located in one of three (3) random configurations.

### 4.5.2 Autonomous Period

The *Match* starts with a thirty-second *Autonomous Period* where *Robots* are operated via pre-programmed instructions only. *Teams* are not allowed to control *Robot* behavior with the *Driver Station* or any other actions during the *Autonomous Period*. The *Driver Station* is placed in a hands-off location during the *Autonomous Period* so that it is evident that there is no human control of *Robots*. The only exception is to allow *Drive Teams* to start their *Robot* with start commands issued on the *Driver Station* Android device. *Teams* must use the built-in thirty-second timer. Following a countdown by field personnel, the *Autonomous Period* begins. *Drive Teams* may issue a *Robot* start command with their *Driver Station* Android device to run an *Autonomous Op Mode*. Failure to adhere to this procedure may subject the *Team* and/or *Alliance* to a *Penalty* as specified in the game rules in section 4.6.2.

The *Autonomous Score* is based on completing tasks during the *Period*. Points are awarded for the following achievements:

- 1) **Repositioning** – A *Foundation* In the corresponding *Alliance Building Site* at the *end of the Autonomous Period* and not in contact with a corresponding *Alliance Robot* will earn ten (10) points for their *Alliance*.
- 2) **Stone Delivery** – An *Alliance* will earn points for *Delivering Stones* from their *Quarry* under their *Alliance’s Skybridge* per the following criteria. Points are awarded based on the order the *Stones* are *Delivered* independently by each *Alliance*.
  - a) *Initial two Stones Delivered* - If these are *Skystones*, the *Alliance* will earn ten (10) points each. If these are *Stones*, the *Alliance* will earn two (2) points each.
  - b) *Remaining Stones Delivered*: Both *Stones* and *Skystones* earn two (2) points each.
  - c) *Each Stone Returned during the Autonomous Period* deducts two (2) points, except if the first *Stone Returned* is a *Skystone*, which deducts ten (10) points.

Note: Points are given only when both the *Robot* and the *Stone* it *Controls* cross completely from the *Loading Zone* to the *Building Zone*. The intent of this rule is to not allow *Robots* using arms to push a *Stone* through, “kickers”, or any other method that does not require the *Robot* to pass completely under the corresponding *Alliance Skybridge*.

- 3) **Navigating** – Each *Robot* that is *Parked* over the tape separating the *Loading Zone* from the *Building Zone* and under their *Alliance’s Skybridge* at the end of the *Autonomous Period* will earn five (5) points for their *Alliance*.
- 4) **Placing** – Each *Stone* (*Stone* or *Skystone*) In the *Foundation* at the end of the *Autonomous Period* earns four (4) points.

#### **4.5.3 Driver-Controlled Period**

Directly following the end of the *Autonomous Period*, *Drive Teams* have five (5) seconds plus a “3-2-1-go” countdown to prepare their *Driver Stations* for the start of the *Driver-Controlled Period*. On the countdown word “go,” the *Driver-Controlled Period* starts, and *Drive Teams* press their *Driver Station* start buttons to resume playing the *Match*.

The *Driver-Controlled Score* is based on completing a series of tasks as outlined below. Points are awarded for the following achievements:

*Stones* and *Skystones* earn points as follows:

- 1) **Stone Delivery** – Each *Stone* (*Stone* or *Skystone*) *Delivered* by going under the corresponding *Alliance Skybridge* for the *Robot* is worth one (1) point to the *Alliance* that *Delivered* the *Stone*. *Stones Delivered* under the *Alliance neutral Skybridge* are worth zero (0) points for this task. *Stones Returned* deduct one (1) point each for the *Alliance* who *Returned* the *Stone*.

Note: Points are given only when both the *Robot* and the *Stone* it *Controls* cross completely from the *Loading Zone* to the *Building Zone*. The intent of this rule is to not allow *Robots* using arms to push a *Stone* through, “kickers”, or any other method that does not require the *Robot* to pass completely under the corresponding *Alliance Skybridge*.

- 2) **Placing** – At the end of the *Match*, each *Stone* (*Stone* or *Skystone*) that is *In* the *Foundation* and not in contact with an *Alliance Robot* when all *Scoring Elements* have come to rest earns one (1) point.
- 3) **Skyscraper Bonus** – An *Alliance* will earn two (2) points for each *Skyscraper Level* of their tallest *Skyscraper* that is not in *Contact* with an *Alliance Robot* when all *Scoring Elements* have come to rest after the *End* of the *Driver-Controlled Period*. If there are multiple *Skyscrapers* at the same height, only one *Skyscraper Bonus* will be earned.

Note: *Teams* may move their *Foundation* into their *Building Site* during the *Driver-Controlled Period* before the start of the *End Game*, so that they are eligible for the *Foundation Moved (End Game)* points, but they do not earn any *Repositioning (Autonomous)* points for the action.

#### **4.5.4 End Game**

The last thirty seconds of the *Driver-Controlled Period* is called the *End Game*. *Driver-Controlled Period Scoring* can still take place during the *End Game*. Except for *Parking*, *End Game* tasks completed prior to the start of the *End Game* will earn zero (0) points for those tasks.

Points are awarded at the end of the *Match* for the following *End Game* achievements:

- 1) **Capping** – An *Alliance* will earn points for placing a *Capstone* On their *Foundation* or any *Skyscraper* on their *Alliance's Foundation*. A *Robot* cannot be in contact with the *Capstone* in order for the points to count. The points are awarded as follows:
  - a) Five (5) points for each *Capstone* that is fully *Supported On* a *Skyscraper* or *Foundation*. A *Capstone* may be placed *On* another legally scored *Capstone* and still earn points.
  - b) One (1) point for each *Level* that *Supports* a *Capstone*. Note: If placed onto another *Capstone*, the lower *Capstone* does not count as a *Level*.
  - c) Multiple *Capstones* on the same *Skyscraper* will each earn points.
  - d) A *Robot* may only *Score* one (1) *Capstone*.
- 2) **Foundation Moved** – An *Alliance* will earn fifteen (15) points if their *Foundation* has been moved *Completely Out* of the *Building Site* by the *End* of the *Match*. The *Foundation* must have been *In* the *Building Site* at the start of *End Game* in order to earn these points.
- 3) **Parking** - An *Alliance* will earn five (5) points for each *Robot* that is *Parked In* their *Alliance's Building Site* at the end of the *Match* (*T=0:00*).

Note: Due to the possibility that *Skyscrapers* may fall when *Robots* try to move the *Foundation*, the *Skyscraper*, *Placing*, and *Capstone* achievements will be *Scored* once all *Scoring Elements* have come to rest following the end of the *Match*.

#### **4.5.5 Post Match**

After the *Match*, field personnel will finalize the *Score*. Referees will signal for the *Drive Teams* to enter the *Playing Field* and retrieve their *Robots* and *Capstones*. *Drive Teams* should return any *Stones* that are *Possessed* by the *Robot* to the *Playing Field*. The *Playing Field* reset crew will set up the *Playing Field* for the next *Match*.

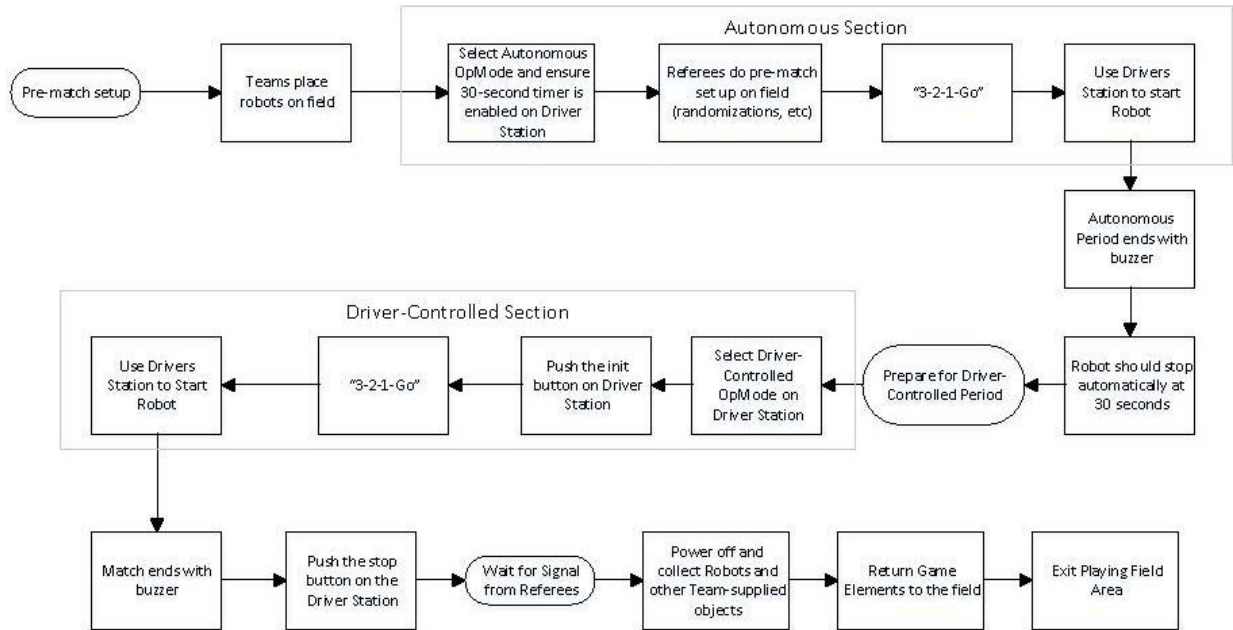
#### **4.5.6 Penalty Scoring**

*Penalty* points are added to the non-offending *Alliance's Score* at the end of the *Match*. *Minor Penalties* give the non-offending *Alliance* five (5) points per occurrence. *Major Penalties* give the non-offending *Alliance* twenty (20) points per occurrence.



### 4.5.7 Flowchart of Match Play

The following figure shows the flow of the *Match* and the actions taken on the *Driver's Station* Android device.



## 4.6 Rules of Gameplay

Gameplay is restricted by the Safety rules (<S#>), the General rules (<G#>), and the Game-Specific rules (<GS#>). Other rules to pay close attention to are the *Robot* rules, *Capstone* rules, the inspection rules, and the tournament rules defined in the Game Manual Part 1. Violation of rules may lead to *Penalties*, *Yellow Cards* and/or *Red Cards*, a *Disabled Robot*, *Disqualification* of the offending *Team* and/or *Alliance* from either a *Match* or the tournament. Rules apply to all periods of play unless specifically called out otherwise. If rules are in conflict, Safety rules take precedence over all rules and Game-Specific rules take precedence over General rules. The official *FIRST* Tech Challenge Question & Answer Forum rulings take precedence over all information in the game manuals.

### 4.6.1 Safety Rules

**<S1> Unsafe Robot or Playing Field Damage** – If at any time the *Robot* operation is deemed unsafe or has damaged the *Playing Field* or another *Robot*, by the determination of the referees, the offending *Robot* may be *Disabled*, and the *Team* may be issued a *Yellow Card*. Re-inspection of the *Robot* is required before it may play another *Match*. Damage that requires significant repair and/or delays subsequent *Match* play is likely to escalate to a *Red Card*.

The intent of this rule is to immediately stop unsafe *Robot* actions or *Playing Field Damage* that is likely to persist with continued *Robot* operation. *Robots* that can continue safe operation without damaging the *Playing Field* will receive a warning and may continue to play the *Match*. *Robots* will be *Disabled* for unsafe operation or *Playing Field Damage* that occurs after the first warning for the tournament. Damage that affects gameplay is likely to escalate to a *Yellow Card*.

**<S2> Robot Extension Outside the Playing Field Perimeter** – If any portion of the *Robot* contacts anything *Outside* the *Playing Field Perimeter*, the *Team* will be issued a *Yellow Card* and it may be *Disabled* immediately for the remainder of the *Match*, unless allowed by Game-Specific rule(s) listed in section 4.6.3. See the game definitions in section 4.4 for a complete description of the *Playing Field Perimeter*.

**<S3> Safety Gear** – All members of the *Drive Team* are required to wear approved eye protection and shoes with closed-toes and a closed-back. If any member of the *Drive Team* is not wearing these safety items, the referee will issue a warning and if the situation is not remedied within thirty seconds, the offending member(s) of the *Drive Team* must leave the *Competition Area* for the remainder of the *Match* and may not be replaced by another *Team* member. Failure to comply with a request to leave the *Competition Area* violates rule <G28>.

The intent of this rule is not to *Penalize* an *Alliance* for *Inadvertent, safe Robot* extension *Outside* the *Playing Field Perimeter*. *Intentional Robot* extension *Outside* the *Playing Field* is not permitted, except as allowed by game-specific rules listed in section 4.6.3

#### **4.6.2 General Game Rules**

**<G1> Drive Team** – Each *Drive Team* shall include up to two *Drivers*, one *Coach*, and one *Human Player* (however only one *Human Player* may represent an *Alliance*). Electronic communications (cell phone, two-way radio, Wi-Fi, Bluetooth, etc.) by *Drive Team* members after an *Alliance* has been called from the queue to the *Playing Field* for its *Match* are not allowed. The first instance of violating this rule will result in a warning, with any following instances during the tournament resulting in a *Minor Penalty*. Items that may be mistaken by a casual observer as being in violation should not be brought to the *Playing Field*. The *Driver Station* is exempt from this rule but must be used only for operating the *Robot*.

**<G2> Playing Field Access** - Team members cannot enter the *Playing Field* for any reason other than to place/retrieve their *Robots*. *Teams* may not measure, test, or adjust *Field* or *Game Elements*. Inspection of the *Playing Field* elements by *Team* members to determine *Scoring* is not allowed. The consequences for violating this rule are:

- a) *Minor Penalty* for violation of this rule during *Match* setup or following the end of the *Match*.
- b) *Major Penalty* for violations of this rule that delay the start of the *Match*.
- c) Violations of this rule outside of normal *Match* play result in a *Yellow Card*.

If a *Team* feels the *Playing Field* is not set up correctly, *Teams* should notify a Referee or FTA prior to the start of the *Match*.

**<G3> Pre-Match Robot Placement** – At the beginning of a *Match*, each *Alliance Robot* must be set up on the *Playing Field* according to section 4.5.1 *Pre-Match* in the Game Manual Part 2. After *Robots* are set up on the *Playing Field*, *Drive Teams* must stand *Completely Inside* their respective *Alliance* or *Human Player Station*.

- a) During the *Qualification Matches*, the blue *Alliance Robots* are set up on the *Playing Field* first, unless the red *Alliance* waives their right to set up on the *Playing Field* second.
- b) During the *Elimination Matches*, the 3<sup>rd</sup> and 4<sup>th</sup> seeded *Alliance Robots* are set up on the *Playing Field* first, unless the higher seeded *Alliance* waives their right to set up on the *Playing Field* second. *Alliance* color doesn't change the seeding of a *Team* during the *Elimination Matches*. If the 4<sup>th</sup> seed defeats the

1<sup>st</sup> seed in the Semi-Finals, they will still have to place their *Robot* on the field first in the Finals because their seeding will be lower than the 2<sup>nd</sup> or 3<sup>rd</sup> seed.

- c) During Elimination *Matches*, 3 *Team Alliances* may only place *Robots* that are intended to compete in that *Match*. Once two *Robots* are placed for the two *Teams* competing in a *Match*, the *Alliance* cannot swap in the 3<sup>rd</sup> *Alliance's* *Robot* for a *Robot* already placed.
- d) *Teams* may implicitly waive their right to place their *Robots* on the *Playing Field* last by placing their *Robots* on the *Playing Field* before or with the opposing *Alliance*. There is no need to tell the referees; *Teams* waive their right by the act of placing their *Robots* on the *Playing Field*.
- e) *Teams* that unnecessarily delay the beginning of a *Match* and/or field reset will incur a *Minor Penalty* for each offense.

*Drive Teams* are expected to stage their *Robots* for a *Match*, and remove it from the *Playing Field* afterwards, safely and swiftly. *Drive Team* efforts that either intentionally or unintentionally delay the start of a *Match* or the *Playing Field* reset are not allowed. Examples include, but are not limited to:

- Late arrival to the *Playing Field*.
- *Robot* maintenance once on the *Playing Field*.

**<G4> Robot Starting Volume** – Before the start of a *Match*, each *Robot* in its starting location must not exceed a volume of 18 inches (457.2 mm) by 18 inches (457.2 mm) by 18 inches (457.2 mm) unless otherwise allowed or restricted by Game Specific Rules detailed in section 4.6.3. The *Pre-Loaded Scoring Element* may extend *Outside* the 18-inch (457.2 mm) cube volume constraint. An offending *Robot* will be removed from the *Playing Field*, is considered a no-show, and receives no Ranking and TieBreaker Points for the *Match*.

After the start of a *Match*, the *Robot* may extend in any dimension unless restricted by the Game-Specific rules detailed in section 4.6.3.

**<G5> Robot Setup/Alignment** – *Teams* may align their *Robots* during Pre-*Match* setup if they do so with legal components that are part of the *Robot* and can be reset to be within the 18-inch (457.2 mm) cube starting volume constraint. A single member of the *Drive Team* may also align the *Robot* by sight if they are next to the *Robot* and does not delay the start of a *Match*. A *Minor Penalty* will be assessed to the *Team* for violation of this rule.

**<G6> Alliance and Human Player Stations** – During a *Match*, the *Drivers*, *Coaches*, and *Human Players* must remain *In* their *Stations*.

- a) The first instance of leaving the *Station* will result in a warning, with any following instances resulting in a *Minor Penalty*. Leaving the *Station* for safety reasons will not result in a warning or *Penalty*.

- b) Opposing *Alliances' Drive Teams* on the same side of the *Field* cannot distract and/or interfere with each other nor of the off-field *Scoring Elements*. Violation of this rule will result in an immediate *Major Penalty* and a possible *Yellow Card*.

The Intent of this rule is to prevent *Team* members from leaving their assigned *Station* during a *Match* to gain a competitive advantage. For example; moving to another part of the *Field* for better viewing, reaching into the *Field*, etc. Simply breaking the plane of the *Station* during normal *Match* play is not a *Penalty*.

**<G7> Starting Gameplay Early** – *Robots* that start playing the game (*Autonomous* or *Driver-Controlled Period*) prior to the start of a *Match Period* receive a *Minor Penalty*. Referees have the option of issuing a *Major Penalty* in place of the *Minor Penalty* if the early start results in a competitive advantage for the offending *Alliance*.

**<G8> Late Start of the *Autonomous Period*** – *Teams* participating in the *Autonomous Period* are expected to press the "start with 30-second" button on their *Driver Station* Android device and then place the *Driver Station* in a hands-off location without delay when field personnel signal the start of the *Autonomous Period*. A *Minor Penalty* is assessed for violating this rule. Referees have the option of issuing a *Major Penalty* in place of the *Minor Penalty* if the late start results in a competitive advantage for the offending *Alliance*.

**<G9> Robot Control During *Autonomous Period*** - During the *Autonomous Period*, *Drive Teams* may not directly or indirectly control or interact with *Robots* or *Driver Stations*. Early stopping of the *Robot* while running its *Autonomous* code is not allowed, except in cases of personal or equipment safety. A *Major Penalty* will be assessed for violating this rule.

**<G10> Parked** – *Robots* must *Park* at the end of the *Autonomous* and *Driver-Controlled Periods* when competition personnel or timer software announce the end of a *Match* period. *Drive Teams* should make their best effort to stop gameplay immediately when the *End of the Period* game sound begins. *Robots* that are not *Parked* following an approximate one second grace period after the conclusion of the game sound receive a *Minor Penalty* and the actions of the *Robot* do not count towards their *Alliance's Score*. Referees have the option of issuing a *Major Penalty* in place of the *Minor Penalty* if the late stop results in a competitive advantage (other than *Scoring*) for the offending *Alliance*.

*Scoring Elements* that were *Launched* (unless disallowed by *Game Specific* rules) before the *End of the Period* are eligible to be counted as *Scored*. Other *Robot Scoring* achievements that occur after the announced end of the *Autonomous Period* and before the start of the *Driver-Controlled Period* do not count towards the *Score* for the *Autonomous* or *Driver-Controlled Periods*.

**<G11> Drive Team Contact with the *Playing Field* or *Robot*** – During a *Match*, the *Drive Team* is prohibited from making contact with the *Playing Field*, any *Robot*, or any *Game Element* (except for allowed *Human Player* activities). The first instance of contact will result in a warning, with any following instances resulting in a *Minor Penalty*. Contact that affects *Scoring* and/or gameplay will result in issuance of a *Yellow Card* at the discretion of the referees. Contact with the *Playing Field*, a *Game Element*, or a *Robot* for safety reasons will not result in a warning or *Penalty*.

For example, a *Game Element* is launched from a *Robot* on the *Playing Field* and it *Inadvertently* hits a *Team* member in the *Alliance Station* and is deflected back onto the field. The *Team* would not receive a *Penalty* because the *Team* member was protecting him/herself (safety). However, if that same *Game Element* is caught and/or directed to a specific location on the *Playing Field*, the *Team* may be issued a *Penalty*.



**<G12> Autonomous to Driver-Controlled Period Transition** – At the conclusion of the *Autonomous Period*, *Robots* will remain in a hands-off state. Field personnel will not enter the field and will not touch *Robots* on the field during the *Autonomous to Driver-Controlled* transition. *Drive Teams* will have 5 seconds to pick up their *Driver Station*. The scoring system display will provide visual and audio cues for *Drive Teams* to pick up their *Driver Stations*. After the 5 seconds, there will be a 3-2-1 countdown and the *Driver-Controlled Period* of the *Match* will begin.

**<G13> Drive Team Coach Driver Station Control** – During the *Driver-Controlled Period*, *Robots* must be remotely operated only by the *Drivers* using the Gamepads connected to the *Team's Driver Station* and/or by software running on the on-board *Robot* control system. The first instance of *Coach* controlling a *Robot* (for example, operating a Gamepad) will result in a warning, with any following instances resulting in a *Major Penalty*. During the *Driver-Controlled Period*, *Drive Team Coaches* and/or *Drivers* are allowed to hold the *Team's Driver Station* Android device and interact with it to select an Op Mode, view information displayed on the screen, and initialize, start, stop, and reset the *Robot*.

**<G14> Certifying the Score at Match End** – Scores will be tracked by field personnel throughout the *Autonomous* and *Driver-Controlled Periods* of the *Match*. At the end of the *Match*, the final *Score* will be certified as quickly as possible. A change in state of a *Game Element* or *Robot* at the end of the *Match* after its final *Score* is recorded will not change an already-recorded *Score*. *Scoring Elements* will not be recounted at the end of the *Match*.

**<G15> Robots Deliberately Detaching Parts** – *Robots* may not deliberately detach parts during a *Match* or leave mechanisms on the *Playing Field* unless permitted by a *Game Specific Rule*. *Possessed* or *Controlled Scoring Elements* are not considered to be a part of the *Robot* for the purpose of this rule. The consequence of deliberately detaching a part is a *Minor Penalty* if it does not *Block* an opposing *Alliance Robot*, *Alliance-specific Scoring Element* or *Scoring Area*. If a deliberately detached component or mechanism affects gameplay by any *Robot*, the offending *Robot* will receive a *Major Penalty* and will be issued a *Yellow Card*. *Robot* parts that are released but remain connected by a tether are considered detached for the purposes of this rule.

Tethered components that move independently of the main *Robot* are considered a detached component and are illegal.

**<G16> Robots Grasping Game Elements** – *Robots* may not grab, grasp and/or attach to any *Game Element*, *Robot*, or structure other than *Scoring Elements*, unless specifically allowed by game-specific rule(s) listed in section 4.6.3. The first instance will result in a warning with any following violations resulting in a *Major Penalty*.

**<G17> Destruction, Damage, Tipping, etc.** – *Robot* actions aimed at the destruction, damage, tipping over, or entanglement of *Robots* or *Game Elements* are not in the spirit of the *FIRST* Tech Challenge and are not allowed unless permitted by *Game Specific* rules. However, *FIRST* Tech Challenge games are highly interactive. *Robot-to-Robot* contact and defensive gameplay should be expected. Some tipping, entanglement, and damage may occur as a part of normal gameplay. If the tipping, entanglement, or damage is ruled to be deliberate or chronic, the offending *Team* will receive a *Major Penalty* and a *Yellow Card*.

**<G18> Pinning, Trapping, or Blocking Robots** – A *Robot* cannot cause an opposing *Alliance Robot* to become *Pinned*, *Trapped*, or *Blocked*. If a referee determines this rule is violated, the offending *Alliance* will receive a *Minor Penalty* for every five seconds that they are in violation. If a referee declares a *Pinning*, *Trapping*, or *Blocking* warning during the *Match*, the offending *Robot* must immediately move away at least 3 feet (0.9 m), approximately 1.5 floor *Tiles*, from the *Pinned*, *Trapped*, or *Blocked Robot*.

A *Robot* cannot incur this type of *Penalty* during the *Autonomous Period* unless it is determined by the *Referee* to be part of a deliberate strategy and will be penalized as described above. If the violation happens during the *Autonomous Period*, the first action done by the offending *Robot* during the *Driver-Controlled Period* must be to move away from the *Pinned, Trapped, or Blocked Robot* or a *Minor Penalty* will be assessed immediately and again for every five-seconds that they are in violation. Game-specific rule(s) listed in section 4.6.3 that further define *Pinning, Trapping, or Blocking* take precedence over this general game rule.

The intent of this Rule is that *Drive Teams* begin to immediately move their *Robots* away and have a five second grace period to move the required distance, and not that they are permitted to intentionally *Block* for up to five seconds.

**<G19> Forcing an Opponent to Break a Rule** – The actions of an *Alliance* or their *Robots* shall not cause an opposing *Alliance* or *Robot* to break a rule and thus incur *Penalties*. Any forced rule violations committed by the affected *Alliance* shall be excused, and no *Penalties* will be assigned.

**<G20> Removing Game Elements from the Playing Field** – *Robots* may not deliberately remove *Game Elements* from the *Playing Field* during a *Match*. *Game Elements* that *Inadvertently* fall *Outside* the *Playing Field* will be returned to the *Playing Field* by field personnel at the earliest safe and convenient opportunity at a non-*Scoring* location approximately where it left the field. *Game Elements* removed from the *Playing Field* in an attempt to *Score* are also not subject to this *Penalty*. *Teams* deliberately removing *Game Elements* from the *Playing Field* will incur a *Minor Penalty* per *Game Element* removed from the *Playing Field*. Game-specific rule(s) listed in section 4.6.3 that allow the removal of specified *Scoring Elements* from the *Playing Field* take precedence over this general game rule.

**<G21> Scoring Elements in Contact with Robots** – *Scoring Elements* in a *Scoring Area* that are in contact with or *Controlled* by a *Robot* on the corresponding *Alliance* for the *Scoring Area* have zero *Score* value. Game-specific rule(s) listed in section 4.6.3 that allow *Robot* contact with *Scoring Elements* take precedence over this general game rule.

**<G22> Post-Match Removal of Game Elements from Robots** – *Robots* must be designed to permit easy removal of *Game Elements* from the *Robot* after the *Match*. *Robots* should also be able to be removed from the *Playing Field* without damaging the *Playing Field*. A *Minor Penalty* will be assessed for violations of this rule.

The intent of this rule is to have timely removal of *Robots* from the *Playing Field* following a *Match*.

*Drive Teams* are expected to stage their *Robots* for a *Match*, and remove them from the *Playing Field* afterwards, safely and swiftly. *Drive Team* efforts that either intentionally or unintentionally delay the start of a *Match* or the *Playing Field* reset are not allowed. Examples include, but are not limited to:

- Failing to exit the *Playing Field* once instructed by a *Referee*.
- Failing to remove *Driver Stations* in a timely manner.

**<G23> Robot Manipulation of Scoring Elements** – *Scoring Elements* that are *Controlled* or *Possessed* by a *Robot* are part of the *Robot* except when determining the location of the *Robot*.

For Example: If a *Robot* possesses a *Scoring Element*, and only that *Scoring Element* breaks the plane of a *Scoring Area*, the *Robot* does not receive points for being *In* that *Area*.

**<G24> Robot or Scoring Elements In Two or More Scoring Areas** – Robots or Scoring Elements that are *In* two or more Scoring Areas earn points only for the highest value achievement. If the achievement values are equal, only one achievement counts as *Scored*. Exceptions to this general rule may be specified in the Gameplay section (4.5) or in the game-specific rules.

**<G25> Disabled Robot Eligibility** - If a referee *Disables* a Robot, it will not be eligible to *Score* or earn points for the remainder of the *Match*. A *Disabled Robot* (whether referee induced or failure) does not earn *Penalties* after becoming *Disabled*. Game-specific rule(s) listed in section 4.6.3 take precedence over this general game rule.

**<G26> Playing Field Tolerances** – Tournament provided *Playing Field* and *Game Elements* will start each *Match* with tolerances that may vary by as much as +/-1.0 inch (25.4 mm). *Teams* must design their *Robots* accordingly.

**<G27> Match Replay** – *Matches* are replayed at the discretion of the Head Referee only for a failure of a non-*Team* supplied *Game* or *Field Element* or verified Wi-Fi interference that was likely to have impacted which *Alliance* won the *Match*.

Unexpected *Robot* behavior will not result in a *Match* replay. *Team*-induced failures, such as low battery conditions, processor sleep time-outs, *Robot* mechanical, electrical, software, or communication failures, etc. are NOT valid justifications for a replaying of a *Match*.

**<G28> Egregious Behavior** – Egregious *Robot* or *Team* member behavior at the *Playing Field*, as determined by the referees, will result in a *Major Penalty* and issuance of a *Yellow Card* and/or *Red Card*. Subsequent violations will result in *Team Disqualification* from the tournament. Egregious behavior includes, but is not limited to, repeated and/or flagrant violation of game rules, unsafe behavior or actions, and uncivil behavior towards *Drive Team*, competition personnel, or event attendees.

**<G29> Illegal Usage of Game Elements** - *Robots* may not deliberately use *Game Elements* to ease or amplify the difficulty of any *Scoring* or game activity. A *Major Penalty* will be assessed for violations of this rule. Continued violations of this rule will escalate to *Yellow Cards* quickly.

**<G30> Inadvertent and Inconsequential** - *Robot* actions that violate a rule may be ruled at the referee's discretion to be *Inconsequential* and *Inadvertent* and will not be *Penalized*.

#### **4.6.3 Game-Specific Rules**

**<GS1> Human Player Supplied Stones and Capstones** – *The Human Player* may deliver *Stones* or *Capstones* into their *Alliance's Depot* only during the *Driver-Controlled Period* with the following restrictions:

- a) Only one *Scoring Element* may be *Delivered* at a time.
- b) A *Human Player* may not *Deliver Stones* and/or *Capstones* prior to the start of the *Driver-Controlled Period*.
- c) *Stones* and *Capstones* may only be hand-delivered to the *Alliance's Depot*. *Teams* may not bring tools or devices to the *Playing Field* for handling the *Stones* or *Capstones*. Accommodations and exceptions for a *Human Players* with disabilities or extenuating circumstances will be made at the discretion of the event coordinator.
- d) A *Human Player* cannot break the vertical plane of the *Perimeter Wall* when there is a *Robot* or *Scoring Element* already in the *Depot*.
- e) A *Human Player* cannot hand-deliver a *Stone* or *Capstone* into the *Playing Field* when there is a *Robot* or *Scoring Element* already in the *Depot*.



- f) Any *Stones* that are hand-delivered by the *Human Player* from the *Stone Supply* during *Autonomous* are not eligible to receive points.
- g) *Stones* and/or *Capstones* must be *In the Depot* and *Completely On the Playing Field* floor prior to being *Controlled* by a *Robot*.

Note: A *Disabled Robot* *In an Alliance Depot* is not considered a safety hazard to the *Human Player*, therefore *Stones* and *Capstones* may continue to be placed. The rule <GS6> *Yellow Card* consequence applies to the *Disabled* opposing *Alliance Robot* *In the Depot*.

Violations of <GS1> result in a *Minor Penalty* per occurrence.

The intent of this rule is to prevent *Robot* to human contact and is meant to ensure *Human Player* safety.

**<GS2> Autonomous Period Interference** – During the *Autonomous Period*, *Robots* may not interfere with the opposing *Alliance's* *Scoring* attempts or contact/disrupt the *Stones* or *Skystones* in the opposing *Alliance's* *Quarry*. A *Major Penalty* will be assessed for each violation of this rule and any *Scoring* by the offending *Robot* that occurs using the opposing *Alliance's* *Game Elements* will not benefit the offending *Alliance*.

**<GS3> Control/Possession Limits of Stones/Capstones** – Once a *Match* begins; a *Robot* may *Control* or *Possess* a maximum of one (1) *Stone* and/or one (1) *Capstone*.

- a) Plowing through any quantity of *Stones* or *Capstones* is allowed but herding or directing multiple *Stones* or *Capstones* to gain a strategic advantage (i.e., *Scoring*, accessibility, defense) is not allowed. The *Penalty* for *Controlling* or *Possessing* more than the allowed quantity is an immediate *Minor Penalty* for each *Stone* or *Capstone* above the limit plus an additional *Minor Penalty* per *Stone* or *Capstone* for each 5-second interval that this situation continues. A double *Major Penalty* will be assessed for each *Stone* or *Capstone* *Scored* while a *Robot* *Controls* or *Possesses* more than the allowed quantity. Continued violation of this rule will escalate to *Yellow Cards* quickly.
- b) *Stones* and *Capstones* *In the Foundation* are exempt from the *Control/Possession Limit*.
- c) *Controlling* or *Possessing* an opposing *Alliance's* *Capstone* is a *Major Penalty*.

**<GS4> Launching of Game Elements** – *Game Elements* may not be *Launched* by a *Robot* or *Human Player*. A *Minor Penalty* will be assessed for every *Launched Game Element*.

**<GS5> Foundation Scoring Interference** – *Robots* may not be *In* their opposing *Alliance's* *Foundation* at any time. *Robots* may not interfere with an opposing *Alliance Robot* that is *In* their *Foundation*. The first instance will result in an immediate *Major Penalty* and an additional *Minor Penalty* assessed for every five seconds that the rule violation persists. Additional occurrences of violations of this rule will escalate to *Yellow Cards* quickly.

The intent of this rule is to prevent game strategies aimed at interfering with *Scoring* and not for *Inadvertent* and *Inconsequential* intrusion.

**<GS6> Blocking Access to the Depot** – *Robots* may not be *In* or *Block* access to the opposing *Alliance's* *Depot*. *Inconsequential* violations of this rule during the *Autonomous Period* will be handled per rule <G30>. The first instance will result in a warning with any following violations resulting in a *Major Penalty* and an additional *Minor Penalty* assessed for every five seconds that the rule violation persists. If the referee declares a *Blocking* access warning, the offending *Robot* must move away at least 3 feet (0.9 m), approximately 1.5 floor *Tiles* from the *Blocked Depot*. Failure to move the required 3 feet (0.9 m) within 5 seconds is considered

an additional violation and will incur the *Penalties* described above. Additional occurrences of violations of this rule will escalate to *Yellow Cards* quickly.

Note: A *Disabled Robot In a Depot* is not considered a safety hazard, therefore *Stones* and *Capstones* may continue to be placed. However, a *Disabled Robot In the opposing Alliance's Depot* still earns a *Yellow Card* due to the possibility of a severe disruption to the ability of the owner of the *Depot* to play the game.

The intent of this rule is to allow *Robot* access to and from their *Alliance's Depot*. See definition of *Blocking and Trapping* in section 4.4.

#### <GS7> **Skybridge Specific Penalties –**

- a) *Robots* may not grab, grasp, or hang on the *Skybridge* pipes. Each occurrence will result in a *Major Penalty*.
- b) *Robots* may not move from one *Zone* to another via the opposing *Alliance's Skybridge* section. Each occurrence will result in an immediate *Major Penalty*.
- c) *Robots* may not prevent an *Opposing Alliance Robot* from moving between one *Zone* to another via the *Neutral Skybridge*. This is considered *Blocking* and will be penalized per <G18>.

<GS8> **Controlling the Opposing Alliance's Foundation –** *Robots* may not *Control* the opposing *Alliance's Foundation* when the *Foundation* is *In* the opposing *Alliance's Building Site* or at any time during *End Game*. The first instance will result in an immediate *Major Penalty* and an additional *Minor Penalty* assessed for every five seconds that the rule violation persists. Additional occurrences of violations of this rule will escalate to *Yellow Cards* quickly.

<GS9> **Descoring –** *Robots* may not remove or reposition *Stones/Capstones* from their opposing *Alliance's Foundation* when the *Foundation* is *In* the opposing *Alliance's Building Site* or at any time during *End Game*. A double *Minor Penalty* will be assessed for each *Stone* that is de-scored. If a *Capstone* is de-scored, a *Major Penalty* will also be assessed.

*Drive Teams* should exercise care when operating around an opposing *Alliance's Foundation* to avoid *De-scoring*.

<GS10> **Foundation Movement –** *Foundations* must remain *Completely In* the *Building Zone*. A *Minor Penalty* will be assessed for every 5 seconds that the *Foundation* is not *Completely In* the *Building Zone*.

<GS11> **Skybridge Safety –** Never step/jump over any section of the *Skybridge*. The first instance will result in a warning to the entire *Team*. The next instance will be a *Minor Penalty*. The next instance will be a *Major Penalty*. Further violations beyond will be considered *Egregious Behavior*.

<GS12> **Drive Teams Touching Robots or Driver Stations after Quarry Randomization –** *Drive Teams* are not allowed to touch or interact with their *Robots* or *Driver Station* once field personnel have begun the randomization process. If this occurs, a *Minor Penalty* will be assessed, and the affected *Robot* is not eligible to earn the *Stone Delivery Score* in the *Autonomous Period*. This *Penalty* only affects the offending *Team*. The non-offending *Alliance* partner *Robot* remains eligible for the *Stone Delivery Scoring* achievement.

## 4.7 Scoring Summary

The following table shows the possible *Scoring* achievements and their point values. The table is a quick reference guide and not a substitute for a thorough understanding of the game manual.

<b>Scoring Achievement</b>	<b>Autonomous Points</b>	<b>Driver-Controlled Points</b>	<b>End Game Points</b>	<b>Reference</b>	<b>When Scored</b>
<i>Autonomous Stone Deliveries:</i> Initial Two - <i>Skystone</i> - <i>Stone</i>  Third and Higher	10 2  2	-	-	4.5.2.2a 4.5.2.2a  4.5.2.2b	As it occurs
<i>Repositioning</i>	10	-	-	4.5.2.1	End of <i>Period</i>
<i>Placing</i>	4	1	-	4.5.2.4 4.5.3.2	End of <i>Period</i>
<i>Navigating</i>	5	-	-	4.5.2.3	End of <i>Period</i>
<i>Driver-Controlled Stone Deliveries</i>	-	1	-	4.5.3.1	As it occurs
Tallest <i>Skyscraper</i> Bonus	-	2 per <i>Skyscraper</i> <i>Level</i>	-	4.5.3.3	End of <i>Match</i>
<i>Capping</i>	-	-	5	4.5.4.1a	End of <i>Match</i>
<i>Capping</i> Bonus	-	-	1 per <i>Skyscraper</i> <i>Level</i>	4.5.4.1b	End of <i>Match</i>
<i>Foundation</i> moved out of <i>Building Site</i>	-	-	15	4.5.4.2	End of <i>Match</i>
<i>Parking</i>	-	-	5	4.5.4.3	End of <i>Match</i>

## 4.8 Rule Summary

The following table shows the possible rule violations and their consequences. The table is a quick reference guide and not a substitute for a thorough understanding of the complete rule descriptions in section 4.6.

<b>Rule #</b>	<b>Rule</b>	<b>Consequence</b>	<b>Warning Disable</b>	<b>Minor Penalty</b>	<b>Major Penalty</b>	<b>Card Issued</b>
<b>Safety Rules</b>						
<S1>	Unsafe <i>Robot</i> or Damage to the <i>Playing Field</i> .	<i>Disable</i> if unsafe operation is likely to persist. Optional <i>Yellow Card</i> . Significant damage and/or delays may escalate to <i>Red Card</i> .	W D			YC* RC*
<S2>	Contact <i>Outside</i> the <i>Playing Field</i> .	Immediate <i>Yellow Card</i> and Optional <i>Disable</i> unless allowed by rule.	D*			YC

Rule #	Rule	Consequence	Warning Disable	Minor Penalty	Major Penalty	Card Issued
<S3>	<i>Drive Team</i> missing safety gear.	Warning and if not resolved within 30 seconds, the offending member(s) of the <i>Drive Team</i> must leave the <i>Competition Area</i> and may not be replaced.	W +			
<b>General Rules</b>						
<G1>	<i>Drive Team</i> using disallowed electronic communication.	Warning followed by a <i>Minor Penalty</i> .	W	1x		
<G2>	<i>Playing Field Access</i> – Pre-Match or Post-Match.	<i>Minor Penalty</i> for pre-Match or post-Match violations. <i>Major Penalty</i> if delay start of <i>Match</i> . <i>Yellow Card</i> if outside of normal <i>Match</i> play.		1x	1x	YC
<G3>	Pre-Match Robot placement.	<i>Minor Penalty</i> if <i>Teams</i> delay start of <i>Match</i> .		1x		
<G4>	Robot starting volume.	Robot is <i>Disabled</i> , powered off, and removed from the <i>Playing Field</i> . <i>Team</i> is considered a no-show.	D			
<G5>	Robot setup alignment devices/ <i>Match Delay</i> .	<i>Minor Penalty</i> for each offense.		1x		
<G6>	a) <i>Drive Team</i> member(s) leaving the <i>Alliance Station</i> .	Warning for the first instance with any following instances resulting in a <i>Minor Penalty</i> .	W	1x	-	-
	b) Opposing <i>Alliances'</i> <i>Drive Teams</i> on the same side of the <i>Field</i> distracting and/or interfering with each other or the off- <i>Field Scoring Elements</i> .	Immediate <i>Major Penalty</i> and a possible <i>Yellow Card</i> .	-	-	1x	YC*
<G7>	Starting Gameplay Early.	<i>Minor Penalty</i> with the option of a <i>Major Penalty</i> if the early start results in a competitive advantage for the offending <i>Alliance</i> .		1x	1x	
<G8>	Late <i>Start of the Autonomous Period</i> .	<i>Minor Penalty</i> with the option of a <i>Major Penalty</i> if the late start results in a competitive advantage for the offending <i>Alliance</i> .		1x	1x	
<G9>	Robot control during <i>Autonomous Period</i> / Early stopping of <i>Autonomous code</i> .	<i>Major Penalty</i> .			1x	
<G10>	Robot is not <i>Parked</i> at end of period.	<i>Minor Penalty</i> and the actions of the <i>Robot</i> that occur after the end of gameplay do not count towards their <i>Alliance's Score</i> . <i>Major Penalty</i> if the late stop results in a competitive advantage for the offending <i>Alliance</i> .		1x	1x	

Rule #	Rule	Consequence	Warning Disable	Minor Penalty	Major Penalty	Card Issued
<G11>	<i>Drive Team</i> contact with the <i>Playing Field</i> , <i>Game Element</i> , or <i>Robot</i> .	Warning for the first instance with any following instances resulting in a <i>Minor Penalty</i> . Optional <i>Yellow Card</i> if contact affects <i>Scoring</i> and/or gameplay.	W	1x		YC*
<G12>	<i>Autonomous</i> to <i>Driver-Controlled Period</i> transition – <i>Robot</i> failure.	No consequences.				
<G13>	<i>Drive Team Coach</i> <i>Driver Station</i> Control.	Warning for the first instance with any following instances resulting in a <i>Major Penalty</i> .	W		1x	
<G15>	<i>Robots</i> deliberately detaching parts.	<i>Minor Penalty</i> . <i>Major Penalty</i> and a <i>Yellow Card</i> if it affects gameplay.		1x	1x	YC
<G16>	<i>Robots</i> illegally grasping <i>Game Elements</i> .	Warning for the first instance with any following instances resulting in a <i>Major Penalty</i> .	W		1x	
<G17>	Destruction, damage, tipping, etc.	Deliberate or chronic violations of this rule will receive a <i>Major Penalty</i> and a <i>Yellow Card</i> .			1x	YC
<G18>	<i>Pinning</i> , <i>Trapping</i> , or <i>Blocking</i> for more than 5-seconds in the <i>Driver-Controlled Period</i> .	<i>Minor Penalty</i> for every five seconds the <i>Robot</i> violates this rule.		1x		
<G20>	Deliberately removing <i>Game Elements</i> from the <i>Playing Field</i> .	<i>Minor Penalty</i> per <i>Game Element</i> deliberately removed from the <i>Playing Field</i> .		1x		
<G21>	<i>Scoring Elements</i> in contact or <i>Controlled</i> with <i>Robots</i> of the corresponding <i>Alliance</i> .	Points are not earned for any <i>Scoring Elements</i> in contact with <i>Robots</i> of the corresponding <i>Alliance</i> .				
<G22>	Delay caused by removal of <i>Robots</i> from the <i>Playing Field</i> and <i>Game Elements</i> from <i>Robots</i> .	A <i>Minor Penalty</i> will be assessed.		1x		
<G28>	Egregious behavior.	<i>Major Penalty</i> plus a <i>Yellow</i> and/or <i>Red Card</i> . Possible <i>Match Disqualification</i> . Subsequent violations result in <i>Team Disqualification</i> for the tournament.			1x	YC RC DQ
<G29>	Illegal Use of <i>Game Elements</i> to ease or amplify <i>Scoring</i> .	<i>Major Penalty</i> will be assessed with any following instances resulting in a <i>Yellow Card</i> .			1x	YC
<b>Game-Specific Rules</b>						
<GS1>	Illegal introduction of <i>Stones</i> and <i>Capstones</i> .	<i>Minor Penalty</i> per occurrence.		1x		
<GS2>	<i>Interference</i> with opposing <i>Alliance Scoring</i> during <i>Autonomous</i> .	<i>Major Penalty</i> will be assessed and <i>Scoring</i> will not count during occurrence.			1x Pts	



Rule #	Rule	Consequence	Warning Disable	Minor Penalty	Major Penalty	Card Issued
<GS3>	1) <i>Control / Possession</i> limits of Stones.	Immediate <i>Minor Penalty</i> per Stone plus an additional <i>Minor Penalty</i> per five seconds. <i>Double Major Penalty</i> if Stone is Scored. May escalate to <i>Yellow Card</i> .		1x+	2x	YC*
	2) <i>Control or Possessing</i> an opposing <i>Alliance Capstone</i>	<i>Major Penalty</i>		-	1x	-
<GS4>	<i>Launching Game Elements.</i>	<i>Minor Penalty</i> per occurrence.		1x		
<GS5>	<i>Foundation Scoring Interference.</i>	<i>Major Penalty</i> is assessed plus an additional <i>Minor Penalty</i> per 5 seconds in violation. May escalate to <i>Yellow Card</i> .		1x+	1x	YC*
<GS6>	<i>Blocking access to opposing Alliance's Depot.</i>	Warning for the first instance with any following instances resulting in a <i>Major Penalty</i> . plus an additional <i>Minor Penalty</i> per 5 seconds in violation. May escalate to <i>Yellow Card</i> .	W	1x+	1x	YC*
<GS7>	<i>Skybridge Penalties:</i>				1x	
	a) <i>Grasp Skybridge.</i>	a) <i>Major Penalty</i>			1x	
	b) <i>Move from one Zone to the other via opposing Alliance's Skybridge.</i>	b) <i>Major Penalty</i>				
	c) <i>Blocking via Neutral Skybridge.</i>	c) Per <G18>				
<GS8>	<i>Controlling opposing Alliance's Foundation when In Building Site or End Game.</i>	<i>Major Penalty</i> is assessed plus an additional <i>Minor Penalty</i> per 5 seconds in violation. May escalate to <i>Yellow Card</i> .		1x+	1x	YC*
<GS9>	<i>Descoring opposing Alliance's Stones/Capstones when Foundation In Building Site.</i>	<i>Double Major Penalty</i> per Stone. <i>Major Penalty</i> per Capstone.			2x 1x	
<GS10>	<i>Foundation Movement not Completely In Building Zone.</i>	<i>Minor Penalty</i> per 5 seconds in Violation.		1x+		
<GS11>	<i>Stepping over Skybridge</i>	<i>Warning</i> for the first instance. <i>Minor Penalty</i> for second instance. <i>Major Penalty</i> for third instance, <i>Yellow Card</i> for fourth instance.	W	1x	1x	1x
<GS12>	<i>Touching Robots/Driver Station after Quarry randomization</i>	<i>Minor Penalty</i> , Robot not eligible for <i>Stone Delivery Score</i> in <i>Autonomous</i>		1x		

Column Key	
W: Warning	1x: <i>Penalty</i> at normal (single) cost
D: <i>Robot Disabled</i>	2x: <i>Penalty</i> at double cost
D*: <i>Robot optionally Disabled</i>	Pts: Points that would have counted without violation
YC: <i>Yellow Card</i> issued	RC*: <i>Red Card</i> optionally issued
YC*: <i>Yellow Card</i> optionally issued	

## Appendix A – Resources

---

### **Game Forum Q&A**

<http://ftcforum.usfirst.org/forum.php>

Anyone may view questions and answers within the *FIRST*® Tech Challenge Game Q&A forum without a password. To submit a new question, you must have a unique Q&A System User Name and Password for your team.

### **FIRST Tech Challenge Game Manuals**

Part 1 and 2 - <https://www.firstinspires.org/resource-library/ftc/game-and-season-info>

### **FIRST Headquarters Pre-Event Support**

Phone: 603-666-3906

Mon – Fri

8:30am – 5:00pm

Email: [Firsttechchallenge@firstinspires.org](mailto:Firsttechchallenge@firstinspires.org)

### **FIRST Websites**

*FIRST* homepage – [www.firstinspires.org](http://www.firstinspires.org)

[FIRST Tech Challenge Page](#) – For everything *FIRST* Tech Challenge.

[FIRST Tech Challenge Event Schedule](#) – Find *FIRST* Tech Challenge events in your area.

### **FIRST Tech Challenge Social Media**

[FIRST Tech Challenge Twitter Feed](#) - If you are on Twitter, follow the *FIRST* Tech Challenge Twitter feed for news updates.

[FIRST Tech Challenge Facebook page](#) - If you are on Facebook, follow the *FIRST* Tech Challenge page for news updates.

[FIRST Tech Challenge YouTube Channel](#) – Contains training videos, Game animations, news clips, and more.

[FIRST Tech Challenge Blog](#) – Weekly articles for the *FIRST* Tech Challenge community, including Outstanding Volunteer Recognition!

[FIRST Tech Challenge Team Email Blasts](#) – Contains the most recent *FIRST* Tech Challenge news for Teams.

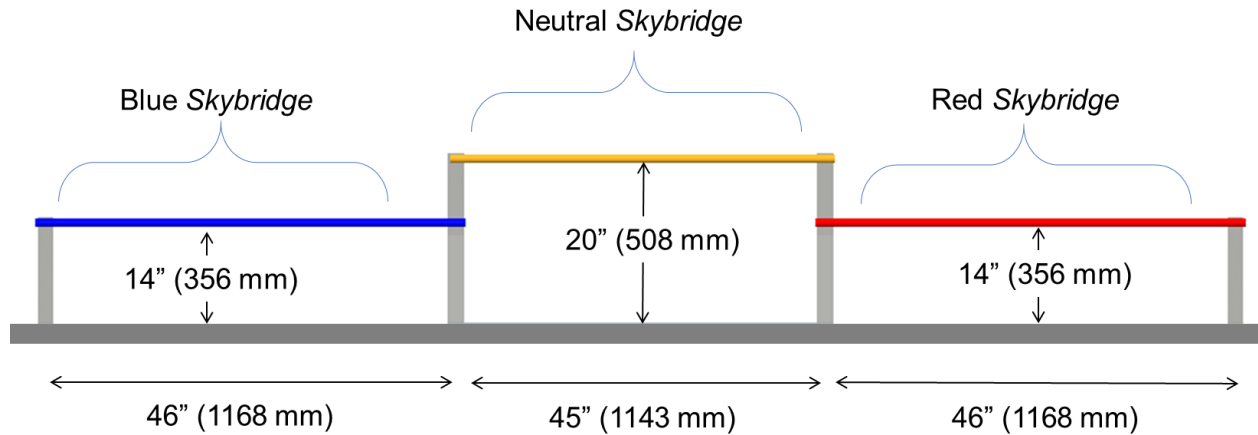
### **Feedback**

We strive to create support materials that are the best they can be. If you have feedback about this manual, please email [firsttechchallenge@firstinspires.org](mailto:firsttechchallenge@firstinspires.org). Thank you!

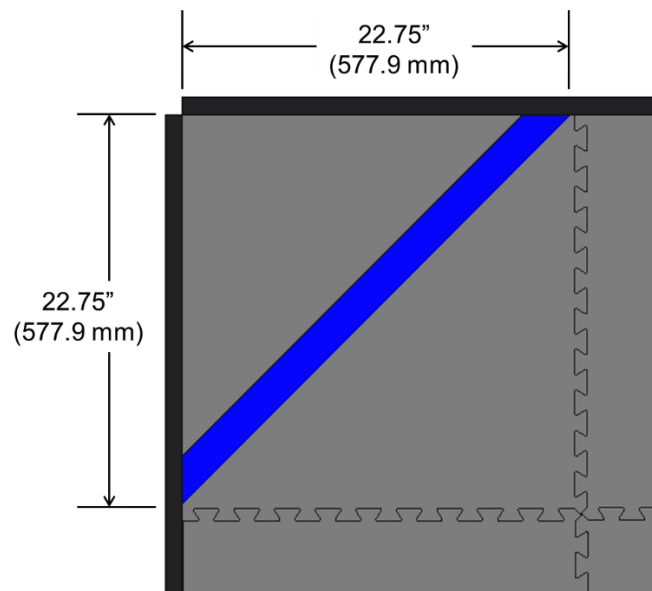


## Appendix B – Field Details

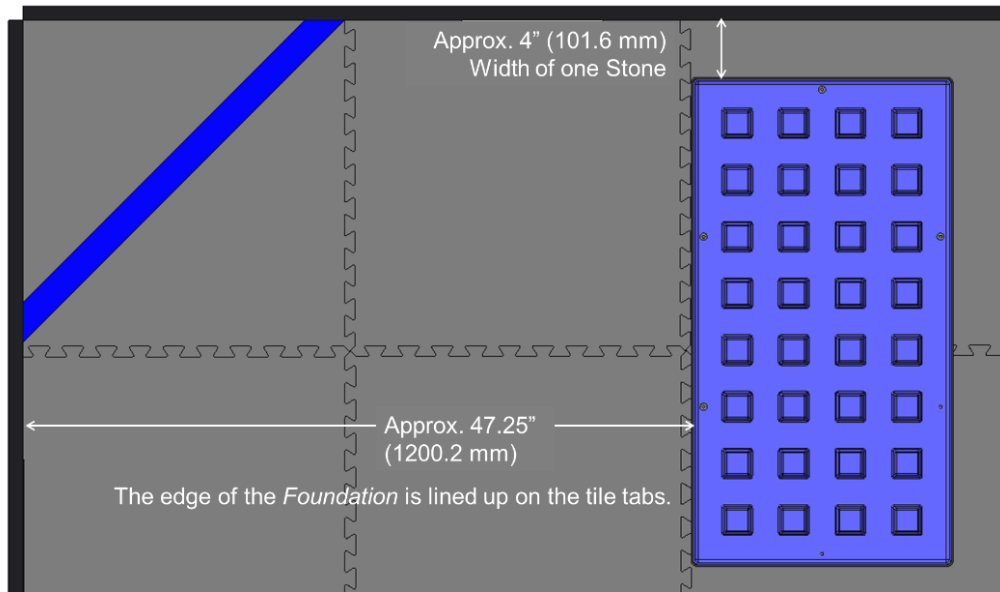
Note: The dimensions in the following diagrams are nominal dimensions, actual dimensions will vary slightly for each *Field*. Robots should be designed to accommodate this variability.



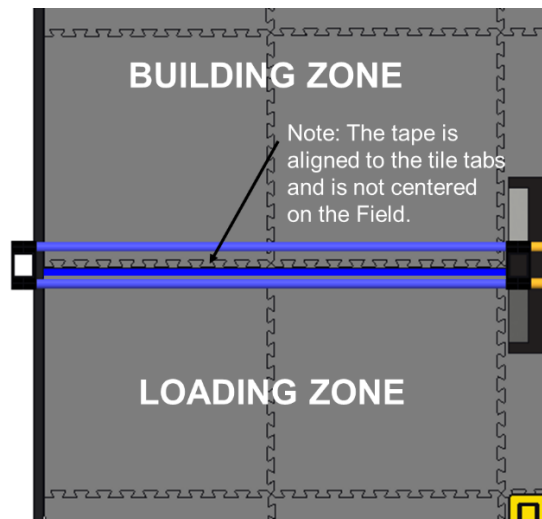
**Figure B-1 Skybridge**



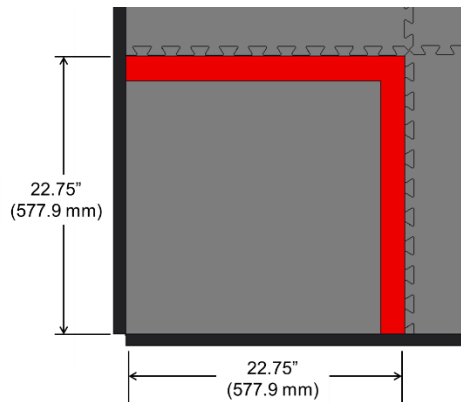
**Figure B-2 Building Site**



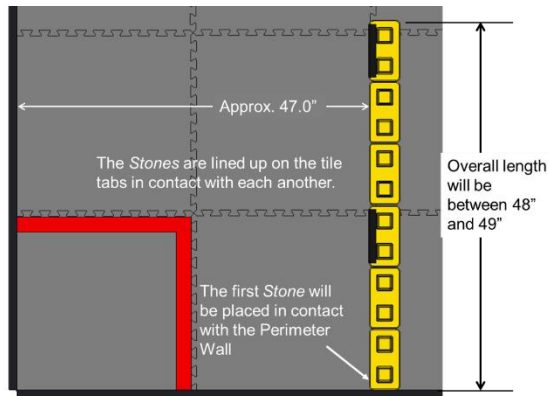
**Figure B-3 Foundation Starting Position**



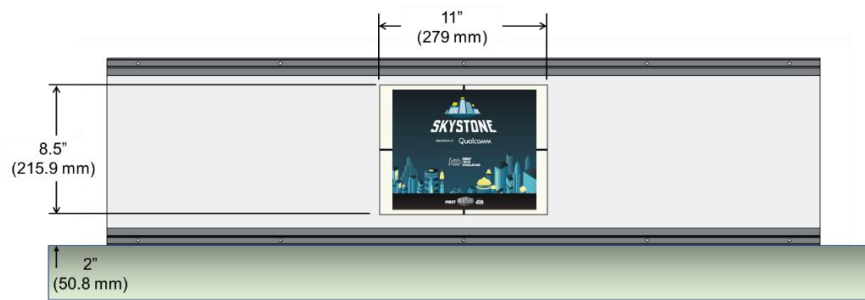
**Figure B-4 Skybridge Tape**



**Figure B-5 Depot**

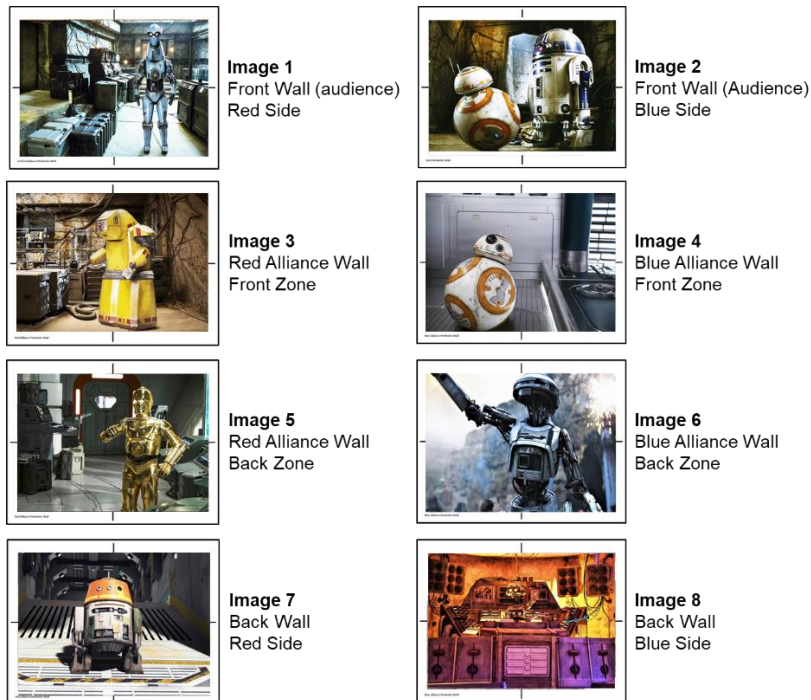


**Figure B-6 Quarry Setup**

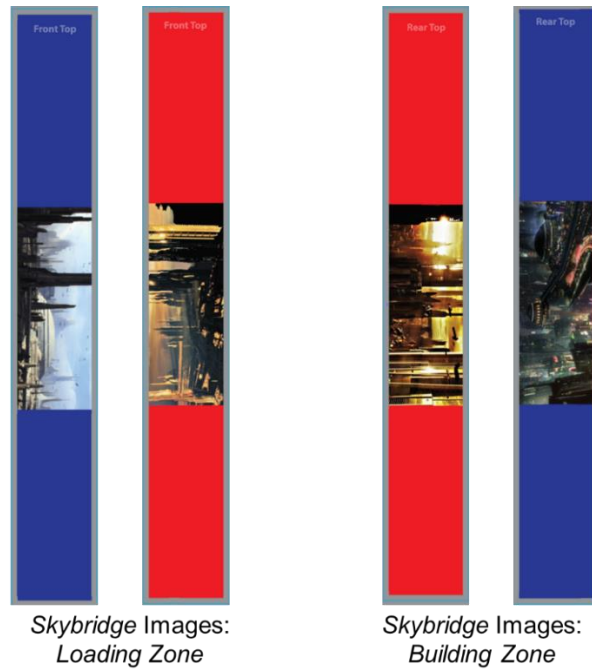


**Figure B-7 Location of *Navigation Target* (as seen from Outside the Field)**

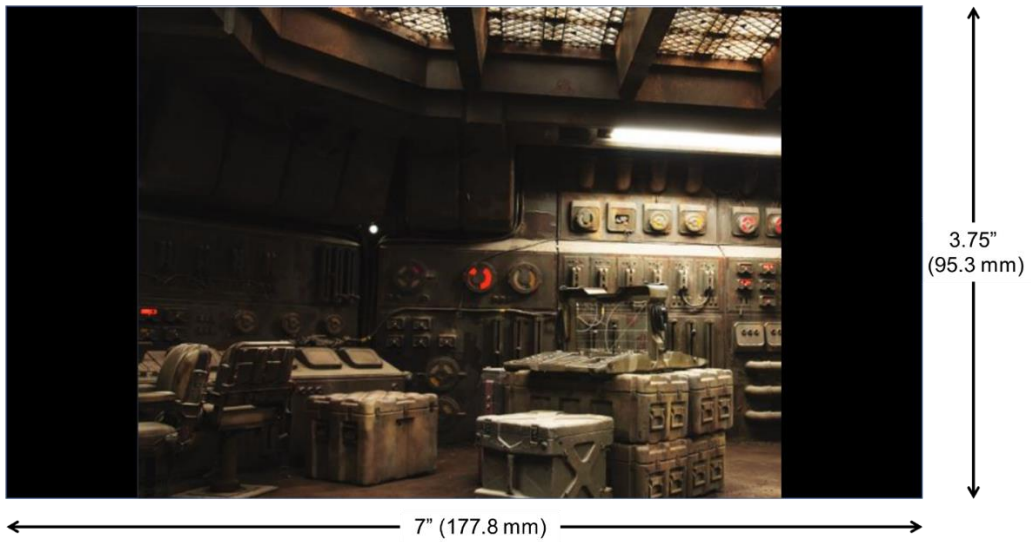
*The exact locations of the Navigation Target are shown in the Field Setup Guide.*



**Figure B-8 *Navigation Target* (as seen from Inside the Field)**



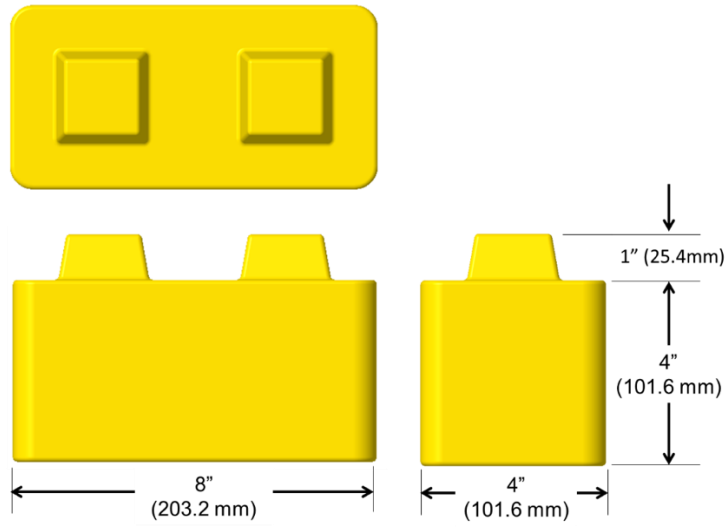
**Figure B-9 Skybridge Images (as seen from Inside the Field)**



**Figure B-10 Skystone Image**

## Appendix C – Scoring Elements

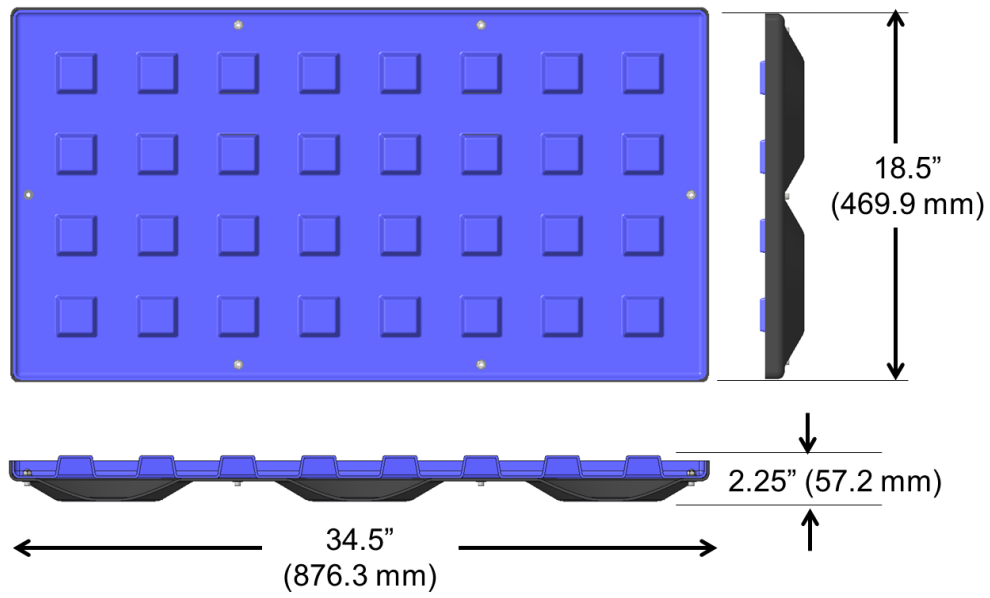
---



**Figure C-1 Stone**

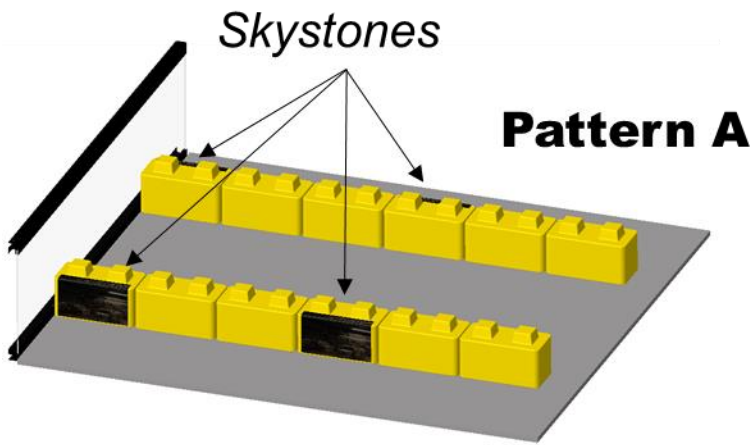


**Figure C-2 Skystone**

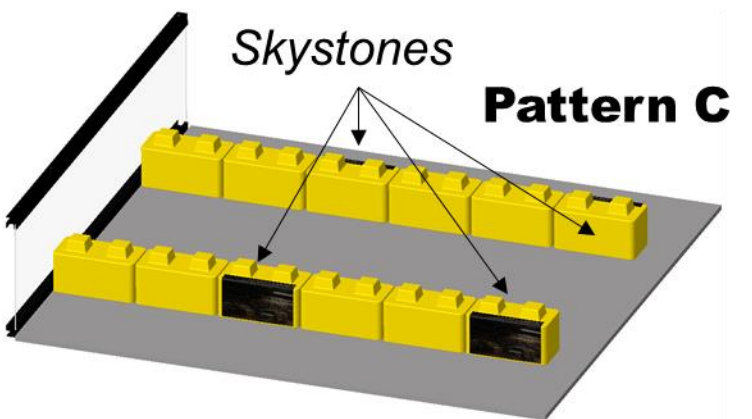
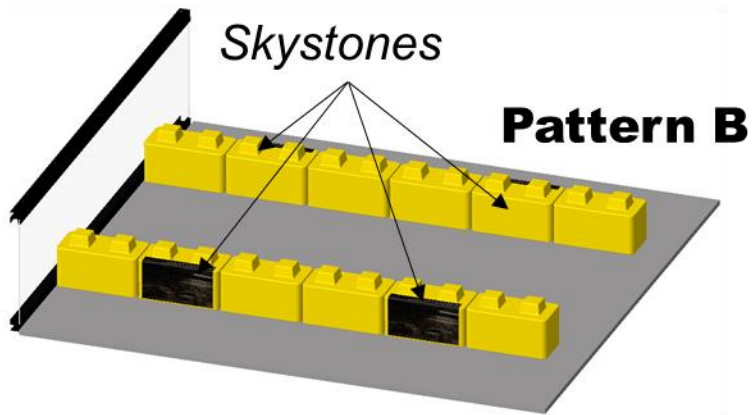


**Figure C-3 Foundation**

## Appendix D – Quarry Randomization



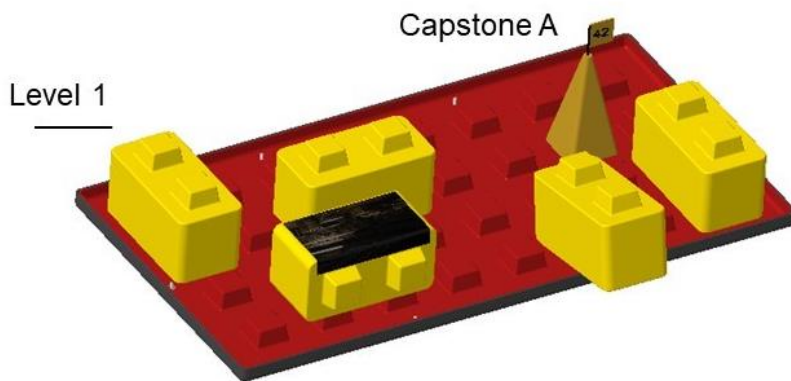
Dice Roll





## Appendix E – Scoring Examples

### Example E-1



Number of *Scored Stones* = 5 points

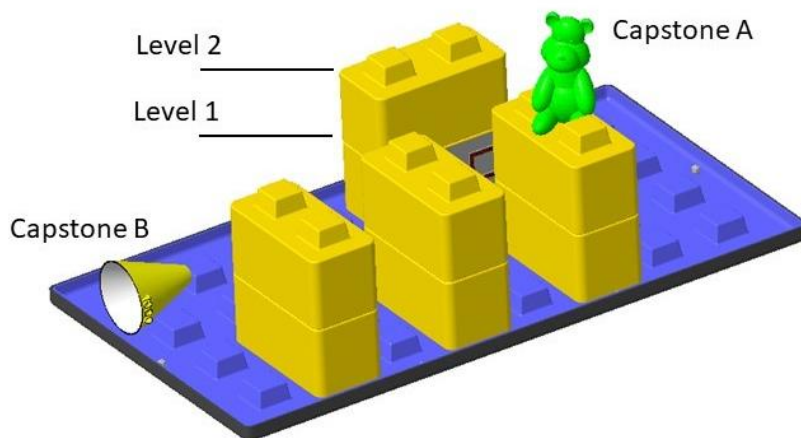
Tallest *Skyscraper Level* = 1  
*Skyscraper Bonus* = 2 points

*Capstone A Level* = 0  
*Capping Bonus* = 5 points  
*Level Bonus* = 0 points

*Capstone B Level* = *Not Placed*  
*Capping Bonus* = 0 points  
*Level Bonus* = 0 points

**Total Score = 12 points**

### Example E-2



Number of *Scored Stones* = 8 points

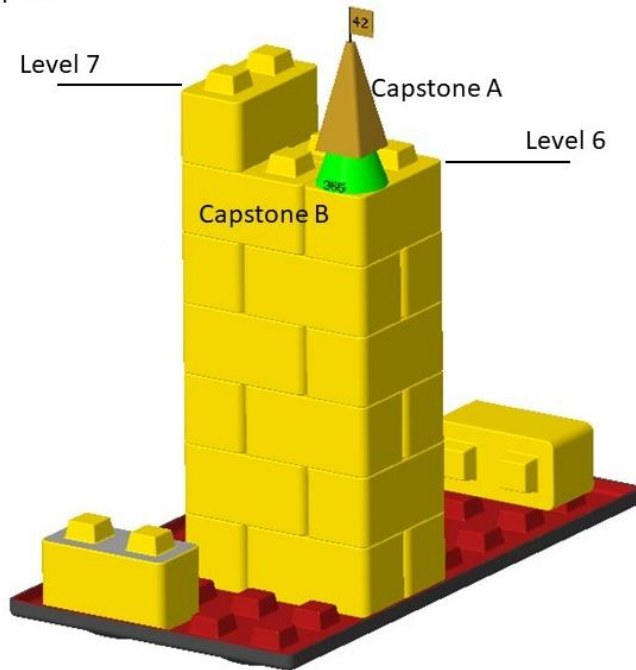
Tallest *Skyscraper Level* = 2  
*Skyscraper Bonus* = 4 points

*Capstone A Level* = 2  
*Capping Bonus* = 5 points  
*Level Bonus* = 2 points

*Capstone B Level* = 0  
*Capping Bonus* = 5 points  
*Level Bonus* = 0 points

**Total Score = 24 points**

**Example E-3**



Number of *Scored Stones* = 21 points

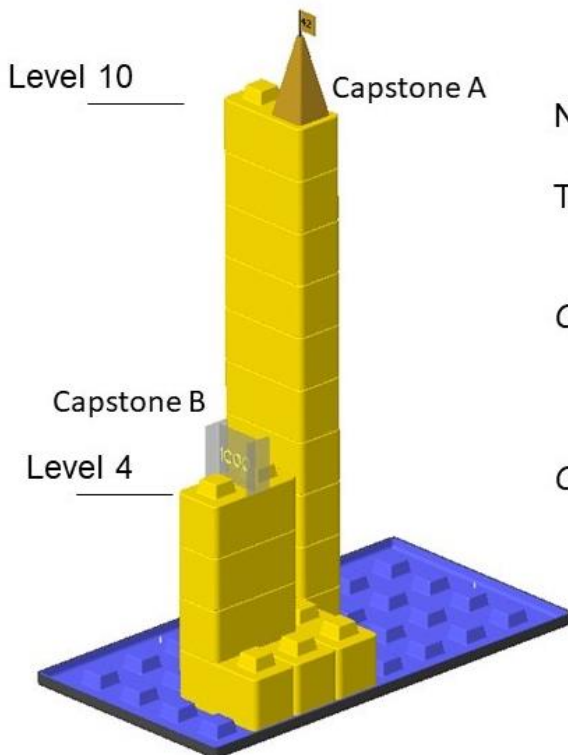
Tallest *Skyscraper Level* = 7  
*Skyscraper Bonus* = 14 points

*Capstone A Level* = 6  
*Capping Bonus* = 5 points  
*Level Bonus* = 6 points

*Capstone B Level* = 6  
*Capping Bonus* = 5 points  
*Level Bonus* = 6 points

**Total Score = 57 points**

**Example E-4**



Number of *Scored Stones* = 16 points

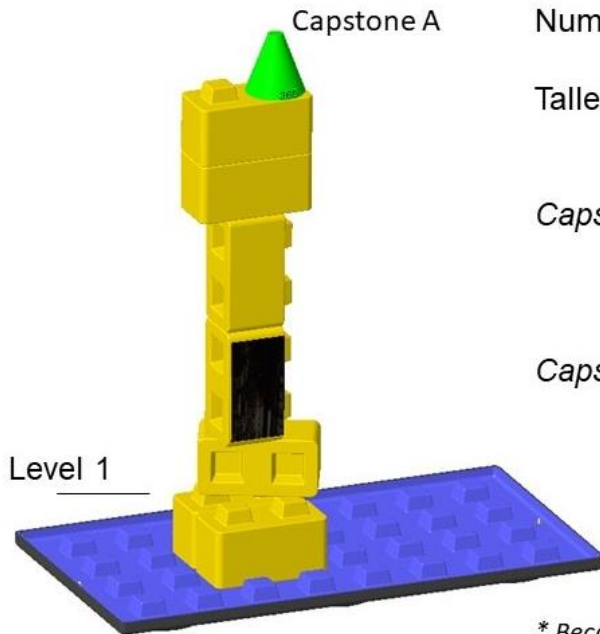
Tallest *Skyscraper Level* = 10  
*Skyscraper Bonus* = 20 points

*Capstone A Level* = 10  
*Capping Bonus* = 5 points  
*Level Bonus* = 10 points

*Capstone B Level* = 4  
*Capping Bonus* = 5 points  
*Level Bonus* = 4 points

**Total Score = 60 points**

**Example E-5**



Number of Scored Stones = 7 points

Tallest Skyscraper Level = 1

Skyscraper Bonus = 2 points

Capstone A Level = 0\*

Capping Bonus = 5 points

Level Bonus = 0 points

Capstone B Level = Not Placed

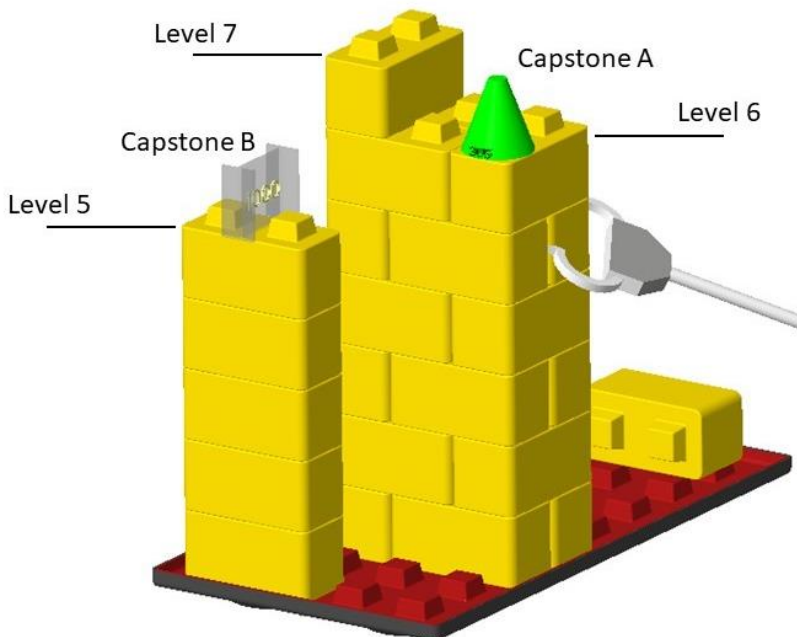
Capping Bonus = 0 points

Level Bonus = 0 points

**Total Score = 14 points**

\* Because Capstone A is not supported by a legal Skyscraper, it does not earn a Level Bonus

**Example E-6**



Number of Scored Stones = 24 points\*

Tallest Skyscraper Level = 5\*\*

Skyscraper Bonus = 10 points

Capstone A Level = 0 \*\*\*

Capping Bonus = 5 points

Level Bonus = 0 points

Capstone B Level = 5

Capping Bonus = 5 points

Level Bonus = 5 points

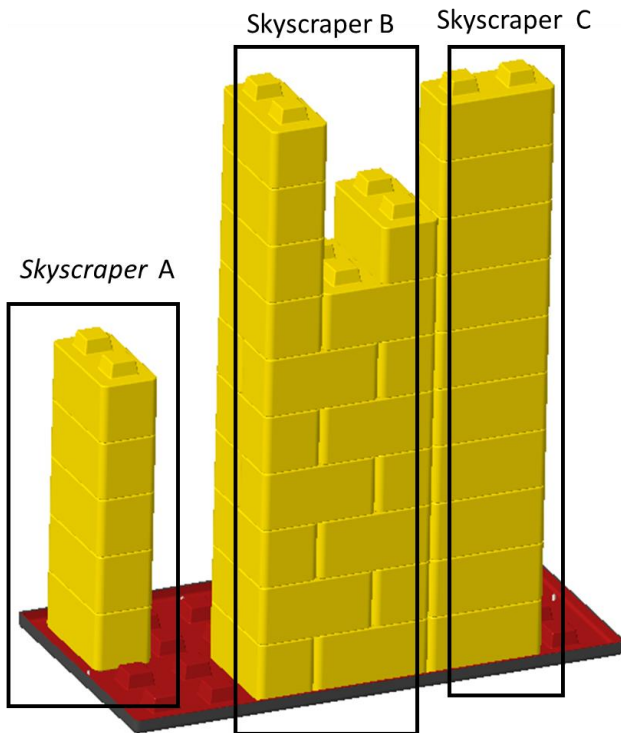
**Total Score = 49 points**

\* A Red Robot is touching one Stone, so that Stone does not count.

\*\* The Level 7 and Level 6 Skyscraper does not count because a Red Robot is in contact with a Stone in the Skyscraper

\*\*\* Capstone A is not supported by a legal Skyscraper

### Example E-7 What is a *Skyscraper*?



*Skyscraper A* consists of 5 *Stones*

*Skyscraper B* consists of 25 *Stones*

*Skyscraper C* consists of 10 *Stones*

Even though *Skyscraper B* has what appears to be two separate peaks, both peaks share *Stones* so it counts as one *Skyscraper*.

Because *Skyscraper C* does not share any *Stones* with *Skyscraper B*, it is considered a separate *Skyscraper*. Therefore a *Robot* touching *Skyscraper B* does not affect the legality of *Skyscraper C*.